

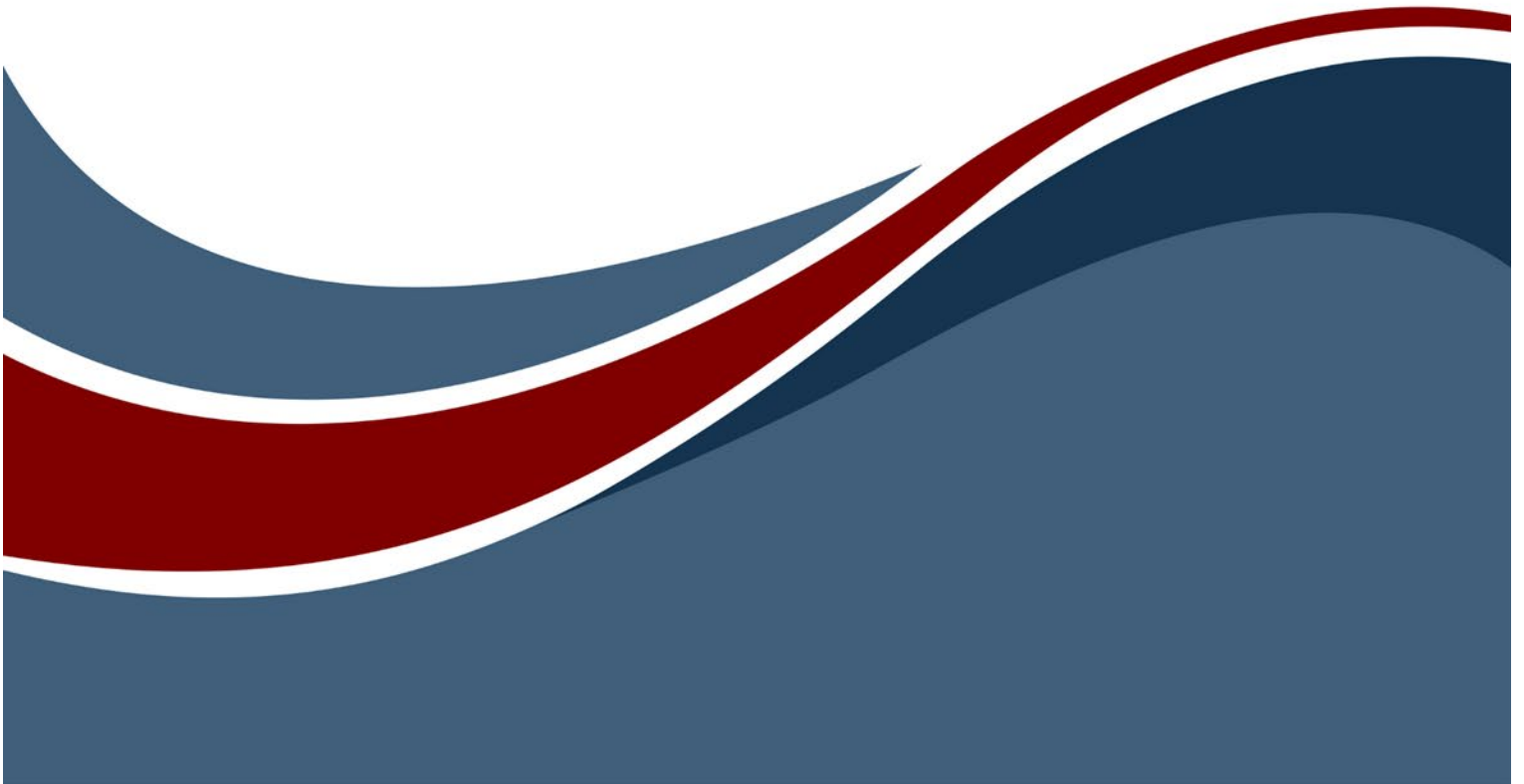

SYSTEMS ENGINEERING GUIDED TOUR



Systems Engineering Guided Tour

Copyright © 2016-2024 Zuken Vitech Inc. All rights reserved.

No part of this document may be reproduced in any form, including, but not limited to, photocopying, language translation, or storage in a data retrieval system, without Vitech's prior written consent.

Restricted Rights Legend

Use, duplication, or disclosure by the U.S. Government is subject to restrictions as set forth in the applicable GENESYS End-User License Agreement and in subparagraph (c)(1)(ii) of the Rights in Technical Data and Computer Software clause at DFARS 252.277-7013 or subparagraphs (c)(1) and (2) of the Commercial Computer Software - Restricted Rights at 48 CFR 52.227-19, as applicable, or their equivalents, as may be amended from time to time.

Zuken Vitech Inc.

2270 Kraft Drive, Suite 1600
Blacksburg, Virginia 24060
+1 540 951 3322 | Fax: +1 540 951 8222
www.vitechcorp.com

Customer Support:

+1 540 951 3999 | support@vitechcorp.com

 GENESYS™ is a trademark of Zuken Vitech Inc. and refers to all products in the GENESYS software product family.

The license and/or entitlement management portions of GENESYS are based upon one or more of the following copyrights: Sentinel® EMSaaS, Sentinel® LDK. Copyright © 2024 Thales. All rights reserved.

Sentinel® is a registered trademark of Thales. Other product names mentioned herein are used for identification purposes only and are trademarks of their respective companies.

Publication Date: December 2024

TABLE OF CONTENTS

- 1. GETTING STARTED WITH GENESYS 1**
 - The Benefits of GENESYS 1
 - Installing GENESYS..... 1
 - Overview of the GENESYS Product Family..... 2
 - GENESYS 2
 - GENESYS Pro..... 2
 - GENESYS Server..... 2
 - Key Concepts 2
 - Integrated System Design Repository 2
 - Comprehensive Systems Design Language™ (CSDL™)..... 3
 - Dynamic Graphical View Generators 4
 - Automatic Document Generation 9
- 2. EXAMINING GENESYS 10**
 - The Sample Problem: Geospatial Library 10
 - Guided Tour Conventions 11
 - Getting Started with GENESYS 11
 - Importing GENESYS Data 12
 - The Main GENESYS Window 19
 - Browser 20
 - Model Assistant and Model Assistant Rules 22
 - Use Case Rule Examples..... 22
 - State Rule Examples 22
 - Entity Property Sheet 23
 - Accessing a Graphical View 24
 - Saving GENESYS Data 25
 - Saving Data in the Local or Server Repository 25
 - Saving Data to a GENESYS Server..... 25
 - Saving Data to GNSX..... 25
 - Importing a Package 27
- 3. STARTING A GENESYS PROJECT 33**
 - The Sample Problem: Geospatial Library 33
 - Summary of the Typical Top-down Process 33
 - Capturing the Problem and Source Requirements 34
 - Loading the Source Document 35
 - Parsing the Document 37
 - Identifying Other Entities 38
 - Defining a Relationship 39
 - Extracting the Child-Level Originating Requirements 41
 - Viewing a Traceability Spider or Hierarchy Diagram 42
 - Adding Entities in a Traceability Spider Diagram..... 44
 - Replacing Icons with Graphics..... 46
 - Capturing Requirements Concerns..... 46
- 4. DEFINING THE SYSTEM AND ITS BOUNDARY AND BUILDING THE BEHAVIOR MODEL 49**

Systems Engineering Guided Tour

Defining the System Environment.....	49
Creating Function Entities	51
Relationships to Lower-Level Decomposed Items and Higher-Level Ancestors	53
Easily Identifying Parent-Child Relationships in Models with Up and Down Arrows	54
Adding Inheritance to Save Time Constructing Models	60
Inserting a Parallel Structure.....	64
Adding Functions to an Activity Diagram	65
Adding Inputs and Outputs	65
Deriving the Behavior for Our System	67
Adding Inputs and Outputs in an Activity Diagram	70
Boolean Triggering Relationship Attribute	72
Adding to the Traceability.....	73
5. EDITING FREE-FORM DIAGRAMS	74
Route Lines	74
Distribute Lines	78
6. COMPLETING THE PHYSICAL MODEL	81
Extending the Component (Physical) Hierarchy	81
Allocating the Functions	82
Completing the Physical Model.....	82
Impact Analysis	84
Ensuring Full Traceability from Source Document to Physical Architecture.....	85
Selecting the Scripting Language	86
Change Control	89
7. CREATING CUSTOMIZED VIEWPOINTS OF THE DATA MODEL	91
Masks	91
Creating a New Mask	91
Deleting a Mask.....	92
Mappings.....	92
Creating a New Mapping	93
Creating a New Global or Local Mapping Item.....	93
Deleting a Mapping Item.....	94
Deleting a Mapping.....	94
Filters.....	94
Creating a New Filter	95
Sorting Filter Criteria.....	96
Deleting Filter Criteria	96
Deleting a Filter	96
Viewpoints	96
Creating a New Viewpoint	97
Sorting Filters	98
Deleting a Viewpoint.....	98
Rule Sets.....	98
Creating a New Rule Set	100
Deleting a Rule Set.....	100

Systems Engineering Guided Tour

Creating a New Rule	101
Sorting Rules, Rule Conditions or Rule Actions	103
Deleting a Rule, Rule Condition or Rule Action.....	103
Duplicating a Mask/Mappings/Viewpoint/Filter/Rule Set.....	103
Applying a Rule Set to a Diagram	104
Rule Set Diagram Legends	105
Generating RDF Files with Viewpoints	109
8. CREATING MULTIPLE VIEWS OF A DIAGRAM	115
Creating a New View Based on the Default View	115
Creating a New View Based on Another Formatted View	116
Viewing All Available Views for a Diagram	116
Displaying View Metadata.....	117
Preventing Accidentally Overwriting a View	117
Saving a Diagram as an Image.....	118
Displaying Multiple Diagram Views on Reports	118
9. STRUCTURED VIEWS OF DIAGRAMS.....	124
10. TABLE VIEWS	126
11. MATRIX VIEWS.....	127
12. GENERATING DOCUMENTATION.....	128
Generating a System Description Document (SDD).....	128
Generating TeamView	129
Congratulations!	133
13. STANDARD REPORTS AVAILABLE IN GENESYS	134



CUSTOMER RESOURCE OPTIONS

Supporting users throughout their entire journey of learning model-based systems engineering (MBSE) is central to Vitech’s mission. For users looking for additional resources outside of this document, please refer to the links below. Alternatively, all links may be found at www.vitechcorp.com/online-resources/.



[Webinars](#)

Immense, on-demand library of webinar recordings, including systems engineering industry and tool-specific content.

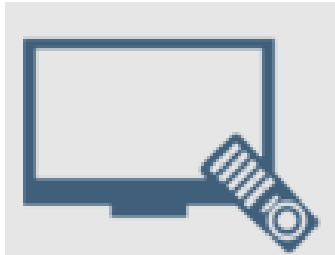

[Screencasts](#)

Short videos to guide users through installation and usage of GENESYS.



[A Primer for Model-Based Systems Engineering](#)

Our free eBook and our most popular resource for new and experienced practitioners alike.



[Help Files](#)

Searchable online access to GENESYS help files.



[Technical Papers](#)

Library of technical and white papers for download, authored by Vitech systems engineers.

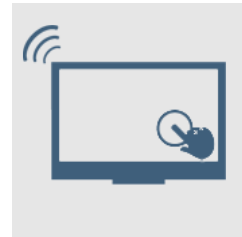

[Technical Support](#)

Frequently Asked Questions (FAQ), support-ticket web form, and information regarding email, phone, and chat support options.

1. GETTING STARTED WITH GENESYS

This section provides an overview of GENESYS:

- Benefits
- GENESYS Product Family
- Key Concepts

The Benefits of GENESYS

Welcome to the GENESYS Guided Tour. This guided tour is intended to familiarize you with basic features of GENESYS, the premier integrated systems engineering tool available today.

The GENESYS Product Suite is a fully integrated, flexible approach to collaborative product design specifically developed by systems engineers for systems engineers. Supported by an experienced staff of engineering professionals with real-world knowledge of the latest approaches and proven project experience, GENESYS puts project success first.

Unlike software tools focused on document-centric or diagram-centric approaches, GENESYS delivers a truly collaborative design-centric approach to product development. GENESYS provides comprehensive traceability from need definition through requirements and analysis to architecture and test. Built upon a proven approach and a central integrated design repository, GENESYS includes a comprehensive behavior modeling notation to better understand the dynamics of your design, integrated product simulation derived directly from your models, and on-demand automatic document and view generation. With numerous views tailored to the multitude of engineering and management tasks, GENESYS enables your team to focus on the creative aspects of engineering and system architecting.

This guided tour can be used in conjunction with GENESYS Pro. Modifications for GENESYS users are provided. Some additional information about this guided tour:

- This guided tour provides a simple, structured walkthrough of a sample product engineering problem to introduce users to the basic concepts and capabilities of GENESYS. It is not intended to demonstrate the full power and flexibility of GENESYS.
- All versions include the sample database, the Geospatial Library, as it has been captured in the tool. The sample solution is presented in the data file at *C:\Program Files\Vitech\GENESYS 2024\Samples\Project Samples* that installed with your GENESYS software. You can use this guided tour to recreate a portion of the solution from scratch as we go along (starting on page 27).
- Help documentation and the GENESYS System Definition Guide that are installed with GENESYS provide in-depth information beyond what is contained in this tour.
- Moving far beyond this introduction, Vitech offers several informational and training opportunities ranging from a one-day seminar on model-based systems engineering (MBSE) to a four-day course for practitioners. Whether you are interested in an MBSE overview or a hands-on class in GENESYS, Vitech offers a course to meet your needs. Please contact Vitech or visit our website (<https://www.vitechcorp.com/training-courses/>) for more information on our training classes.

Installing GENESYS

If you haven't yet installed the GENESYS software, please download the appropriate installation guide from our website at <https://www.vitechcorp.com/software-documentation/>. The installation guide walks you through installing, activating the software, and starting the software.

NOTE: GENESYS 2024 supports 64-bit machines and can no longer be installed on 32-bit machines. The application files will now be installed in the 64-bit *Program Files* directory instead of the previous *Program Files (x86)* directory.

Systems Engineering Guided Tour

If you have any questions or concerns regarding installation, licensing, or training for your GENESYS product(s), please contact us:

- For installation or general customer support: support@vitechcorp.com
- For licensing: licensing@vitechcorp.com
- For information on systems engineering and GENESYS training, visit our website at:

www.vitechcorp.com

or contact your Account Executive

+1 540.951.3322

info@vitechcorp.com

Overview of the GENESYS Product Family

The GENESYS software suite brings the proven STRATA™ methodology together with an enterprise-ready architecture, giving you the ability to deliver MBSE seamlessly and consistently across your project team. GENESYS is an open architecture tool based on familiar standards, so you can focus on design instead of trying to get disparate tools to work together. GENESYS takes the guesswork out of implementation and delivers context-driven modeling for complex systems engineering problems.

GENESYS

GENESYS provides individuals, small teams, and distributed users a complete MBSE development solution ready for immediate use against a locally installed and maintained repository – yet also adds the ability to connect to a collaborative design environment, as required. Enjoy a robust product that includes a rich requirements management capability, multiple modeling notations in traditional or SysML view sets, integrated discrete-event simulation, comprehensive architecture analysis, verification and validation, and robust, on-demand documentation.

GENESYS Pro

Incorporating all the features found in GENESYS, GENESYS Pro delivers comprehensive support for DoDAF 2.0, including the full complement of available views and reports, providing a single vehicle that enables team-wide perspective and analysis and the industry-exclusive ability to deliver answers and insight in multiple formats, regardless of the input approach. Whether working independently or as part of the collaborative enterprise team, GENESYS Pro provides the ultimate answer in capability and flexibility.

GENESYS Server

Part of a large, complex, or data-rich effort? GENESYS Server functions as a remote repository and enables GENESYS and GENESYS Pro users the ability to operate offline and independently or as part of the collaborative engineering team operating together in one concurrent database. GENESYS Server provides a secure, convenient gateway for the team to operate in unison, taking advantage of the team-wide consolidation of information.

As the engineering team centerpiece, GENESYS Server offers unparalleled ease of use, team-wide system-level insight, live access to the latest system changes, comprehensive analysis, and instant, thorough documentation.

Key Concepts

Integrated System Design Repository

GENESYS's integrated system design repository supports the many individuals who are adding, deleting, changing, and reviewing design information that results in the specification of a system. This centralization allows all team members to work from a common, controllable baseline. Additionally, this approach is key to providing consistency of the entities in the system design and assures that all design views (graphic and otherwise) are always synchronized and consistent.

Comprehensive Systems Design Language™ (CSDL™)

Our approach to attaining an explicit system specification is grounded in the use of the Comprehensive Systems Design Language (CSDL) provided with GENESYS. CSDL is a formal, structured language which avoids the ambiguity inherent in using common English to define or specify a system. The precise meaning of each language concept is fixed and documented to enhance team communication and assure unambiguous interpretation of specifications using this language. The data model repository is structured by the CSDL, which is being extended by the use, if needed. CSDL is an Entity-Relationship-Attribute (ERA) language augmented by graphical structures with semantic meaning. The CSDL is based on the following primitive language concepts:

- Entities correspond to nouns in English. Entities define objects and serve as the basic units in the system repository. GENESYS groups these entities into one of several classes (e.g., **Component**, **Function**, etc.) in the system repository.
- Relations are similar to verbs. To be precise, a relation that defines a link between two entities corresponds to the mathematical definition of a binary relation. Relations are not commutative; each relationship has a definite subject and object. However, for each relationship, there is a complementary relationship that defines the link from the object to the subject. For example, when you allocate a **Function** entity to a **Component** entity (using the *allocated to* relation), GENESYS automatically creates the *performs* relation linking the entities in the reverse direction.
- Attributes further describe entities much like adjectives modify nouns. The attributes of an entity serve to define critical properties of entities. For instance, attributes of a **Component** would include the component Number and component Type.
- Attributed-Relationships (i.e., attributes on relationships) correspond to adverbs in English. The attributes of a relationship serve to define critical properties of the relationship. For instance, attributes of a *consumes* relationship would include the quantity being consumed.
- Structures provide specification of semantically explicit system control constructs (Concurrency, Iteration, Loop, Multiple Exit, Replication, Selection, and Sequence). Using this explicit notation, the behavior of the system can be validated and shown to be executable using a discrete event simulator. The simulator dynamically interprets a behavior representation, so the simulation is always synchronized with the current model contained in the system design repository.

The data repository consists of entities that are modified by attributes and related to other entities. This structure corresponds to the object-oriented approach. Entities are represented as objects with the attributes stored as data within the objects. The relations then define the interaction between objects.

In GENESYS, the CSDL is referred to as a schema (or the project metadata). The diagram below illustrates a subset of the basic schema, showing some of the primary systems engineering classes and relationships between them.

Systems Engineering Guided Tour

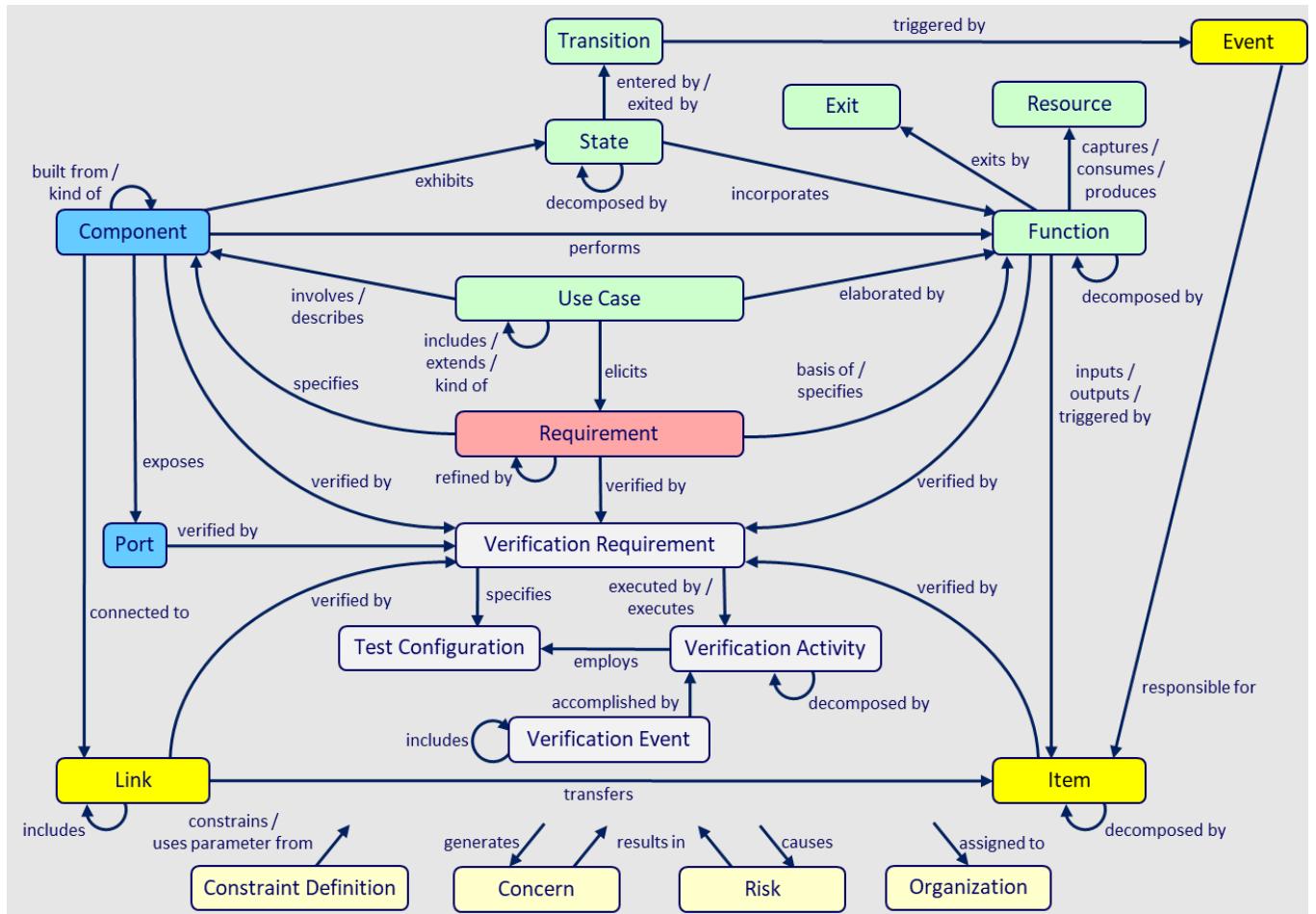

Figure 1 Primary Systems Engineering Entities

Dynamic Graphical View Generators

GENESYS dynamically generates diagrams directly from the system design repository ensuring that they are consistent with current design details. A change made in any view changes the design information in the database repository and, conversely, a change made to the database repository is automatically reflected in the graphical views.

GENESYS delivers a mixture of traditional systems engineering and SysML representations enabling you to satisfy the specific needs of your project. GENESYS provides many different graphical views (listed below) to meet the interests of both engineering and management personnel. This feature allows the system design to be viewed in as many perspectives and layers of abstraction as necessary to understand the model:

- Hierarchy and Spider Diagrams: graphically display several layers of relationships between entities on a single diagram such as functional, physical, and traceability hierarchy views.
- Package Diagrams: display arbitrary clustering of model entities to communicate groupings and interrelationships of interest.
- Requirements Diagrams: show system requirements and their relationships to logical and physical components of the solution.
- Use Case Diagrams: describe the functionality of a system in terms of how its users interact with the system to achieve their goals.
- Functional Flow Block Diagrams (FFBD): show functional flow, including control logic.

Systems Engineering Guided Tour

- Activity Diagrams and Enhanced Functional Flow Block Diagrams (EFFBD): portray behavioral flow, control logic, and inputs/outputs/triggers.
- Sequence Diagrams: represent interactions between functions and their corresponding components.
- Integration Definition for Function Modeling (IDEF0) Diagrams: show functions, inputs, outputs, controls, and mechanisms.
- N2 (N-squared) Diagrams: display functions/components and their internal and external interactions in a matrix format.
- Block Definition Diagrams: show composition and classification of the physical architecture.
- Physical Block Diagrams, Interface Block Diagrams, and Internal Block Diagrams: show composition and connectivity (both physical and logical) of the physical architecture.
- State Transition Diagram: shows the logical transition of a system through various states of operation.
- Parametric Constraint Diagram: used to create systems of equations that can constrain the properties of blocks.
- Class Diagram: UML diagram used to describe the structure of a system by showing the system's classes, their attributes, operations (methods), and the relationships among objects.

As you design diagrams, GENESYS' built-in features refine the layout to automatically space and align items on the diagram, prevent overlapping of nodes when applying layouts, and anchor diagram items to prevent them from inadvertently moving.

GENESYS makes it easy to manipulate diagrams and move items around on the diagram. There are also easily accessible commands on the *Diagram* ribbon that you can use to enhance your diagrams like the Distribute Lines command that evenly distributes node connections.

GENESYS users can undo and redo actions on all diagrams, saving a lot of time fixing diagrams.

Any action that changes the state of the diagram can be undone and redone. This includes layout changes like changing colors and sizes of nodes and moving items on the diagram. It also includes database transactions like creating and deleting entities, relationships, and attributes on the diagrams.

Eliding (Hiding) Diagram Content

The **Presentation Mode** command, accessed on the *Diagram* ribbon, enables GENESYS users to elide (hide) various content in diagrams in various contexts. Elision is a SysML concept that enables both delivery of comprehensive, complete, correct representations from underlying models and enables customers to focus on areas of interest by hiding content.

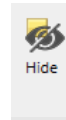

1. To mark an item on a diagram for elision, select it and click the **Hide** icon on the *Diagram* ribbon, or right-click the item and select **Hide** on the drop-down list that appears.

NOTE: To mark several diagram items for elision at once, hold the **SHIFT** key down while selecting items.

Any selectable object in the diagram can be elided, including nodes, lines, and overlay objects like images, notes, and shapes.

NOTE: Dependent content that would not appear on the diagram if the object it is dependent on were not present will also be hidden.

The diagram display mode determines if the elided content will be displayed on the diagram.

Systems Engineering Guided Tour

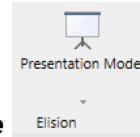

2. Select the display mode by clicking the **Presentation Mode** icon on the *Diagram* ribbon and then selecting one of the four display mode options (*Standard*, *Marked*, *Hidden (with label)*, *Hidden*) from the drop-down menu that displays.

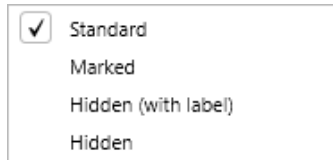

The four display modes are shown below in the Activity Diagram.

Standard Display Mode

Standard display mode is the default mode for all diagrams. In *Standard* display mode, all diagram content displays, including items marked as elided.

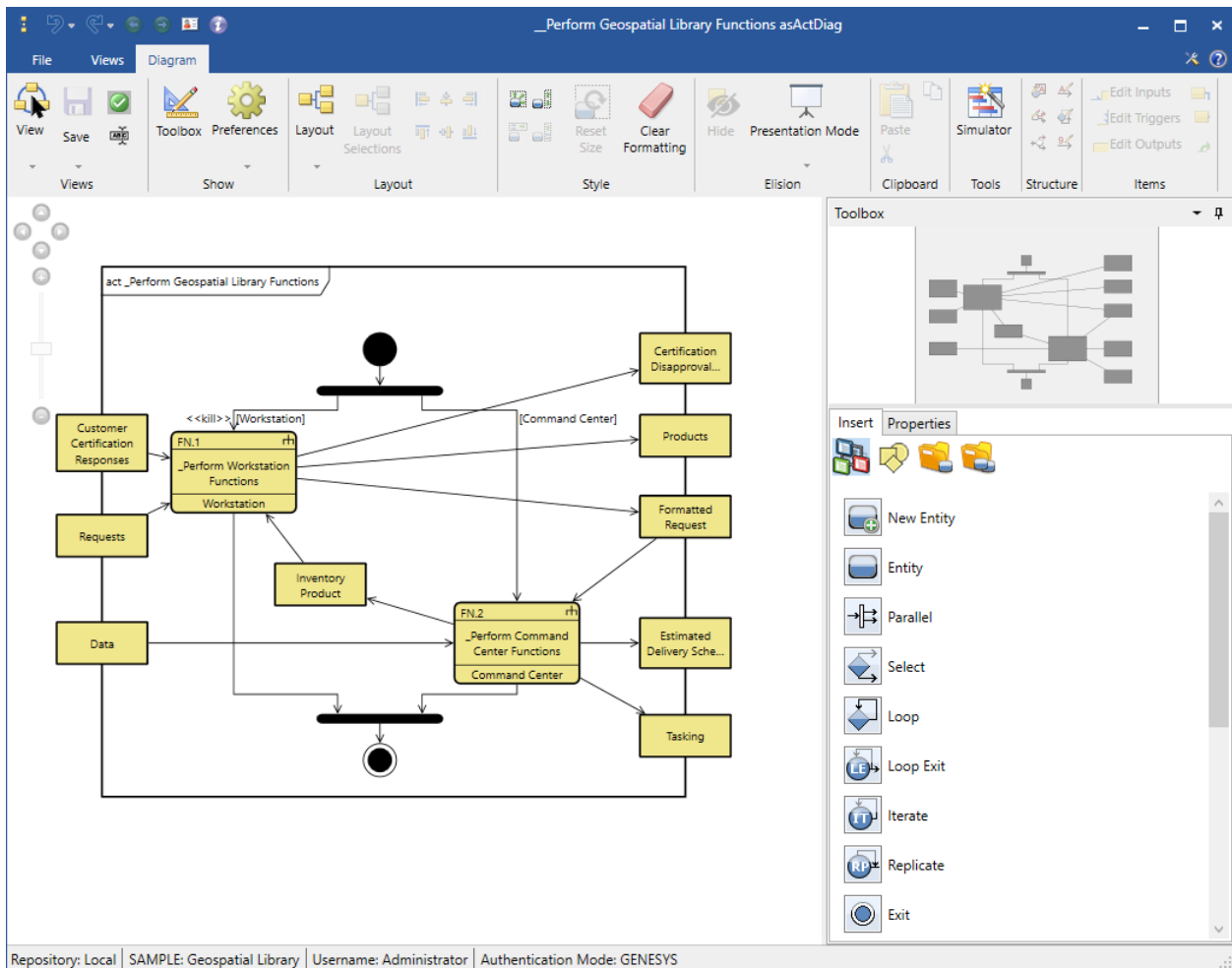

Systems Engineering Guided Tour

Marked Display Mode

In *Marked* display mode, all diagram content that is marked as elided, and all dependent content, is displayed with dashed borders and *italicized* text.

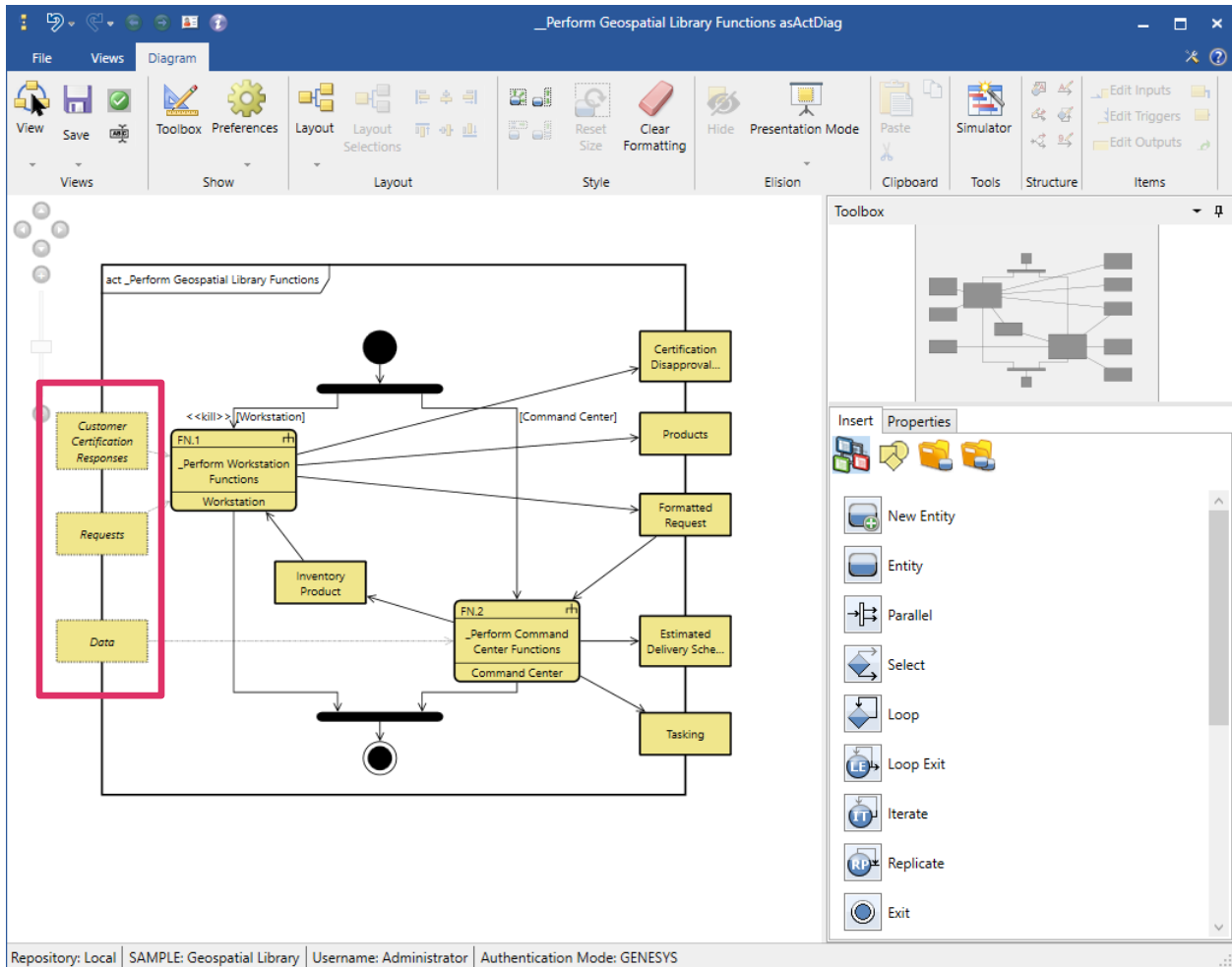

Systems Engineering Guided Tour

Hidden (with Label) Display Mode

Hidden (with label) display mode hides all diagram content marked as elided and all dependent content.

A SysML-style frame block displays “*elided*” on the upper right corner of the diagram frame. For technical audiences, it may be important to clearly communicate that some content in the diagram has been hidden.

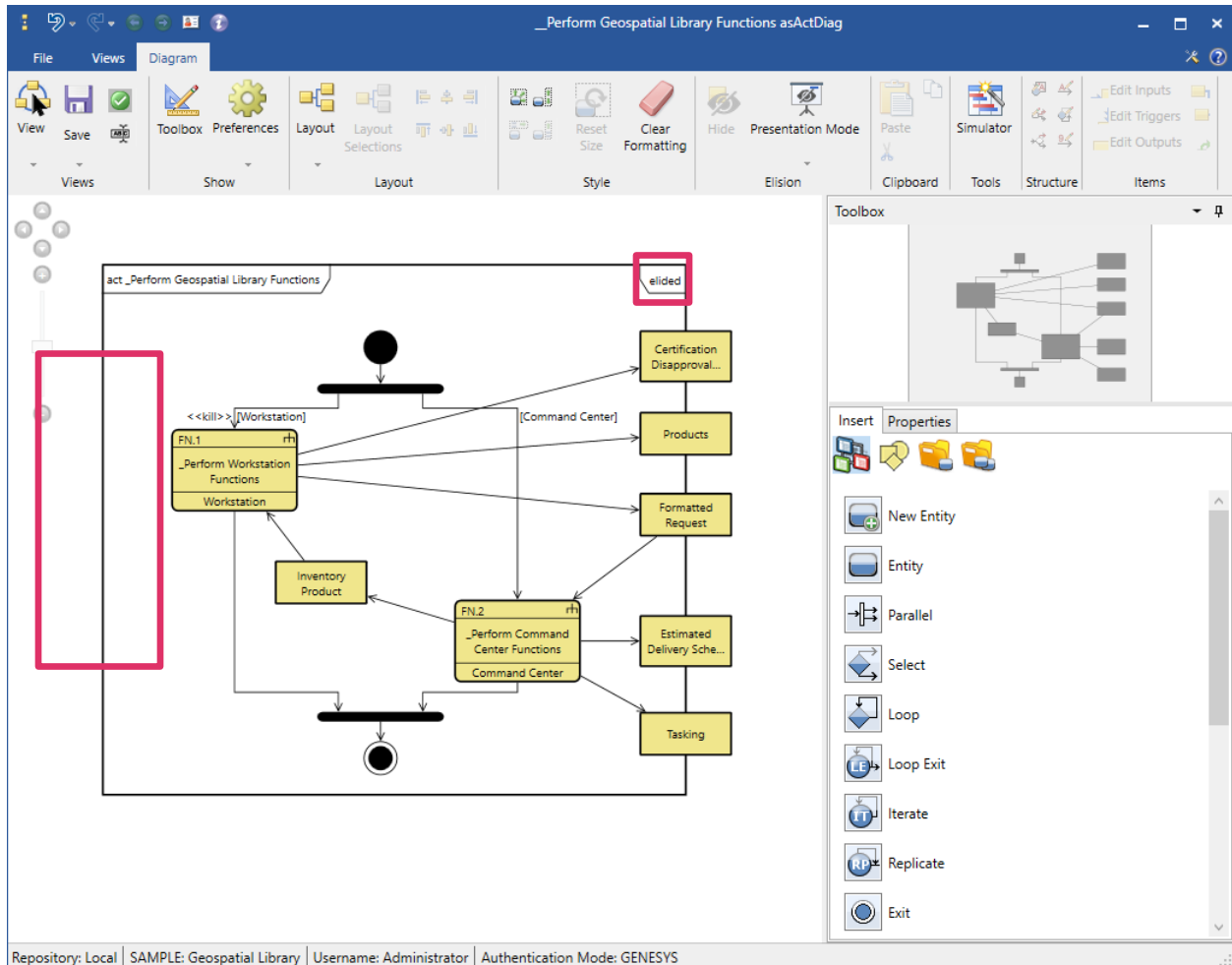

Systems Engineering Guided Tour

Hidden Display Mode

Hidden display mode hides all diagram content marked as elided and all dependent content in the diagram.

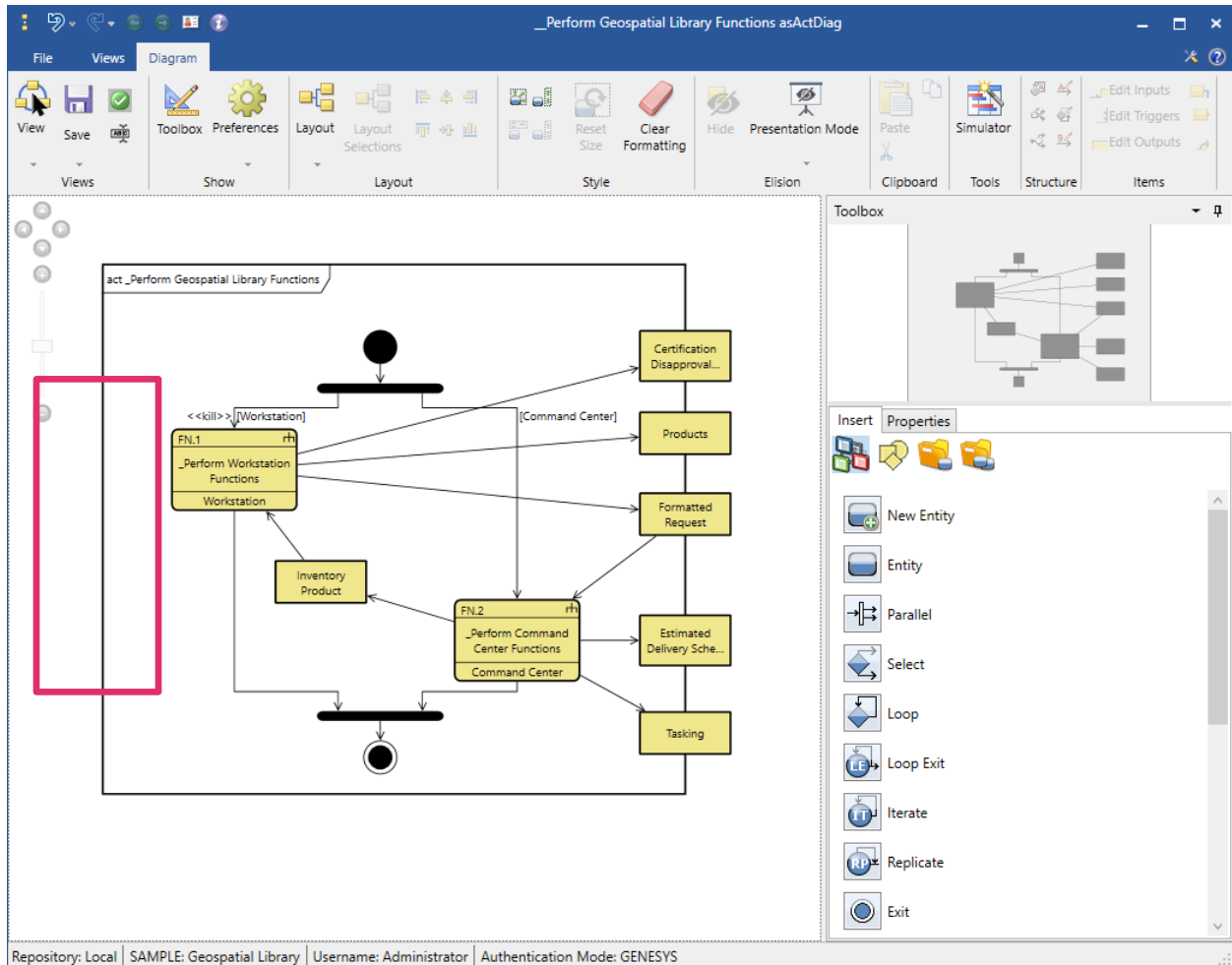

The display mode is saved as a setting for the diagram after a user selects a new display mode and then saves the diagram. The diagram will open the next time with the saved display mode.

When viewing a diagram, users can switch back and forth between the display modes by selecting the options on the *Elision* drop-down menu.

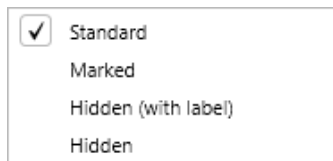

Automatic Document Generation

The GENESYS report generator enables users to extract information from the GENESYS system design repository and present it in virtually any desired format. Reports allow users to view the system design information in diverse ways. Reports in GENESYS can range from a simple query (e.g., a list of all open concerns) to complex, formal documents (e.g., a System/Segment Specification). Reports and analyses for engineering or management support are generated through more than 50 standard queries and report

Systems Engineering Guided Tour

templates¹ provided with GENESYS. Reports in GENESYS can be generated in the following formats: PDF, HTML, MHT, RTF, XLS, XLSX, CSV, and TXT.

The structure of a report is controlled by a report entity that instructs the report generator how to query the system design database repository to gather data and format the information for each portion of the report. Users can develop custom reports and queries. Reports are written using the report designer in GENESYS, and no scripting is necessary for basic reports.

2. EXAMINING GENESYS

This section provides more information on the GENESYS tool:

- Launch GENESYS
- Import a data file into GENESYS.
- Look at basic GENESYS windows.
- Save a data file from GENESYS.

The Sample Problem: Geospatial Library

In this section, we will use a sample database for the Geospatial Library to provide an overview of GENESYS and its features. The context diagram below provides a high-level view of the system we will use throughout this guided tour. You may find it helpful to refer to this diagram as you build the system structure while working through the guided tour.

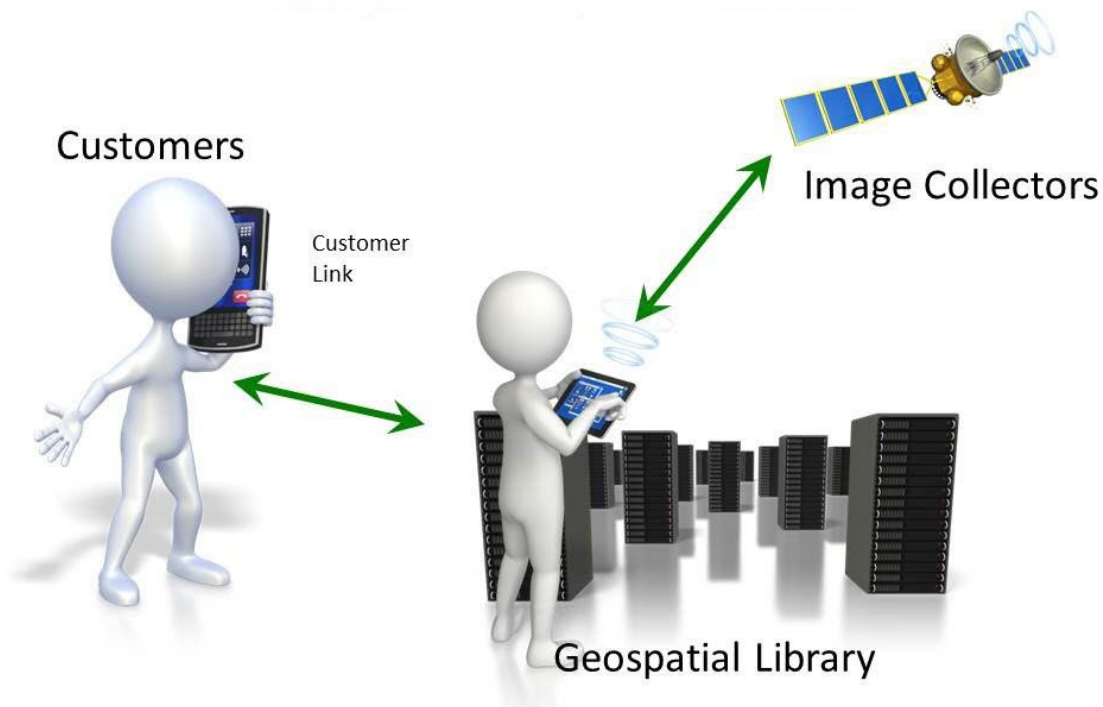

Figure 1 Geospatial Library (GL) Overview

The Geospatial Library demonstrates the use of automated systems engineering support tools. As defined, this demonstration system accepts requests for imagery information, determines the best way for the

¹ A list of the full set of reports provided with GENESYS is shown on page 60.

Systems Engineering Guided Tour

system to respond to the request, and then provides the requested information to the requestor. In the process of acquiring the requested information, the system may generate tasking orders for a set of imagery data collectors.

Guided Tour Conventions

The following special styling is used throughout the guided tour to help you navigate.

Font Style	Description
Function	Classes
Number	Attributes
<i>allocated to</i>	Relationships
Contact Emergency Response	User selections and inputs
<i>File > Import...</i>	GENESYS commands, buttons, icons or tabs

Getting Started with GENESYS

This section will guide you in getting started with GENESYS. In this section, you will import a sample file, receive an overview of the basic menus and features, and save your work in progress.

Once you have installed GENESYS, launch the application.

1. Click the **Windows Start** button.
2. Select *All Programs*, open the *GENESYS 2024* folder, and click *GENESYS 2024*.
3. The following window displays. Enter the default username “Administrator” and the default password “admin”, then click **OK** or press the **Enter** key.

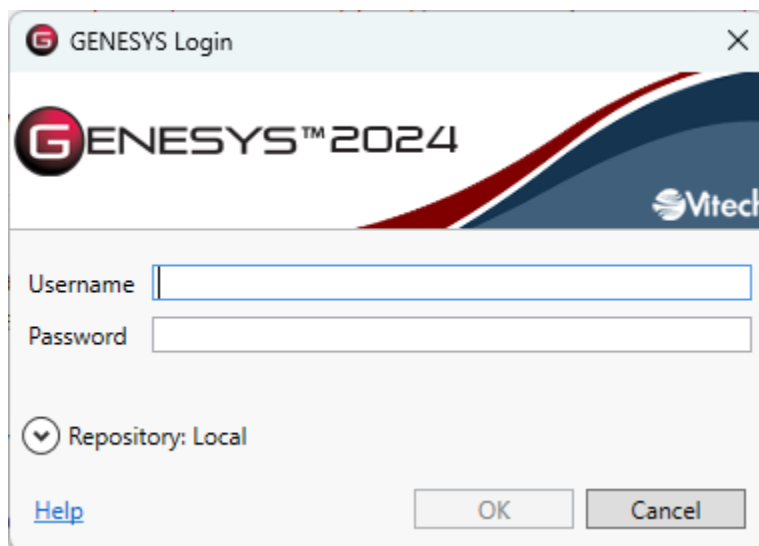

Systems Engineering Guided Tour

When you have successfully logged into GENESYS, the home screen displays.

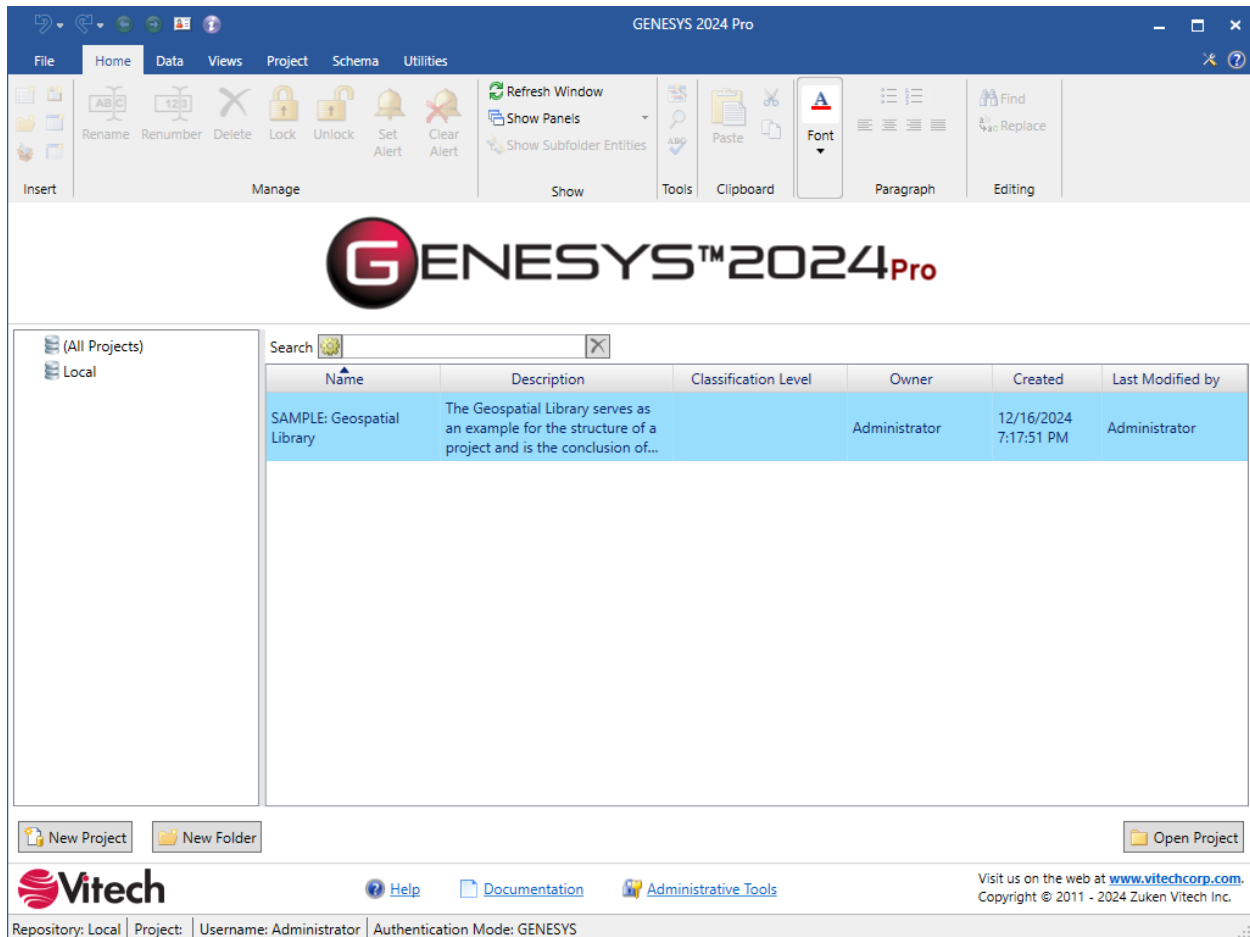

When you open GENESYS, you are logged into a database containing zero, one, or more projects. A database (also known as a repository) can contain multiple projects with each project containing its own set of data (referred to as the system design repository). You can select an existing project or create a new project by either directly importing an existing project or by selecting **New Project** and entering a project name.

Importing GENESYS Data

To introduce you to GENESYS, we want to import a project, so we can see the GENESYS system design repository populated with data. We will use the Geospatial Library sample project which has already been created in GENESYS and then exported to the `C:\Program Files\Vitech\GENESYS 2024\Samples\Project Samples` directory. In general, this import/export capability of GENESYS allows you to transfer a GENESYS project from one computer to another or make a backup copy of the data.

In Section 3, *Starting a GENESYS Project*, you will learn how to use GENESYS by building this sample project yourself.

To import a GENESYS data file:

1. In GENESYS, click the **File Menu**.

Systems Engineering Guided Tour

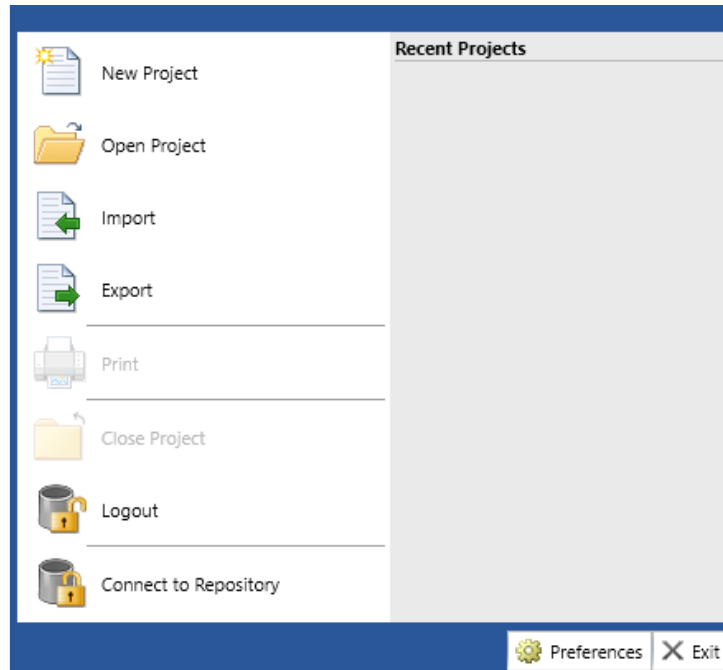

2. Select **Import**. This opens the Import GENESYS File dialog.

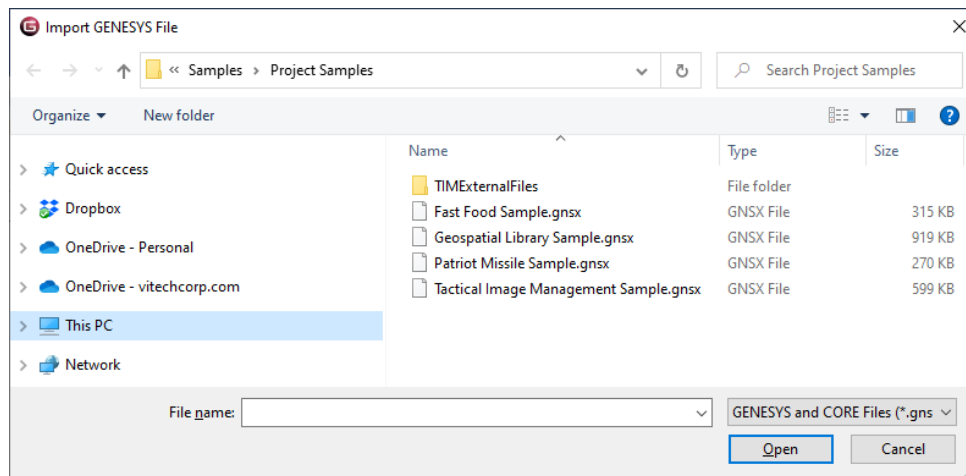

3. Navigate to the `C:\Program Files\Vitech\GENESYS 2024\Samples\Project Samples` directory and select the file named `Geospatial Library Sample.gnsx`.
4. Click **Open**. The Import Wizard will appear allowing you to control the import.
5. In Step 1, since our GNSX file contains only one project, click **Next**.

Systems Engineering Guided Tour

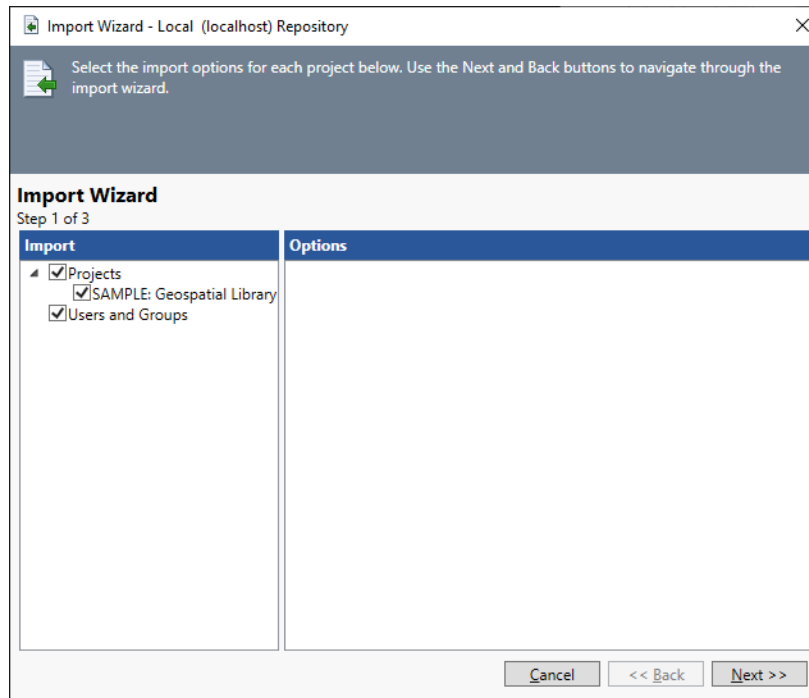

6. In Step 2, since we want to create a new project rather than importing it into an existing project, click **Next**.

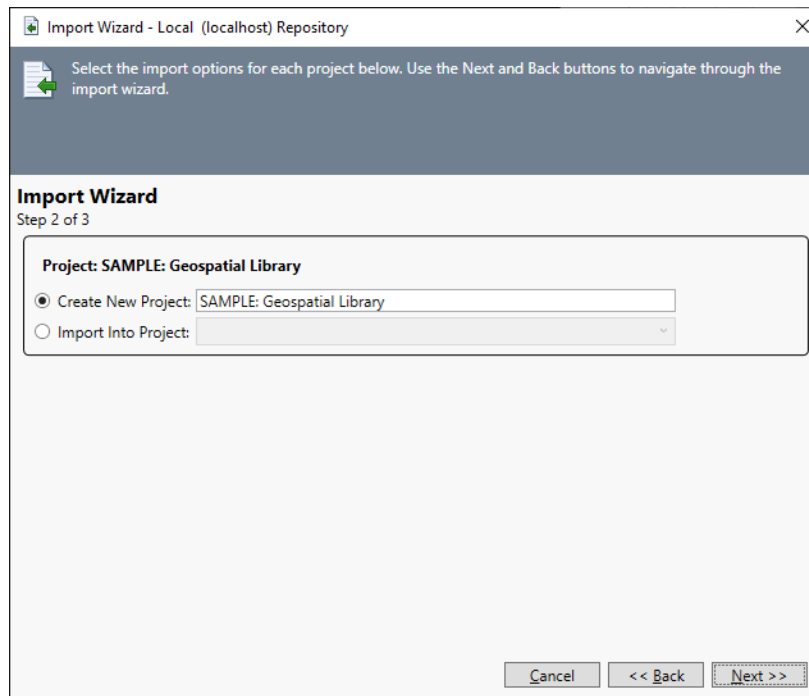

7. In Step 3, to begin the import click **Import**.

Systems Engineering Guided Tour

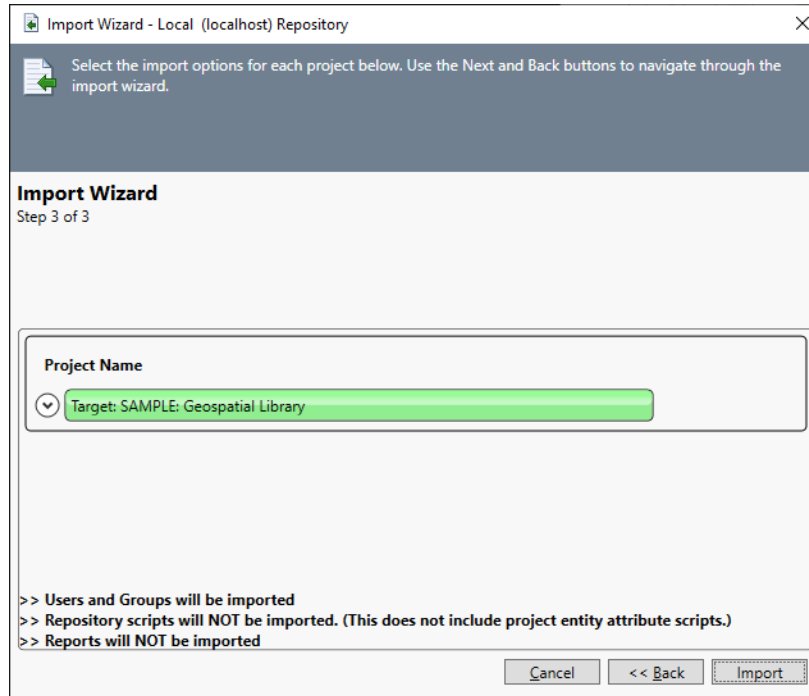

The Job Monitor will show the progress of building the new project and importing the project data.

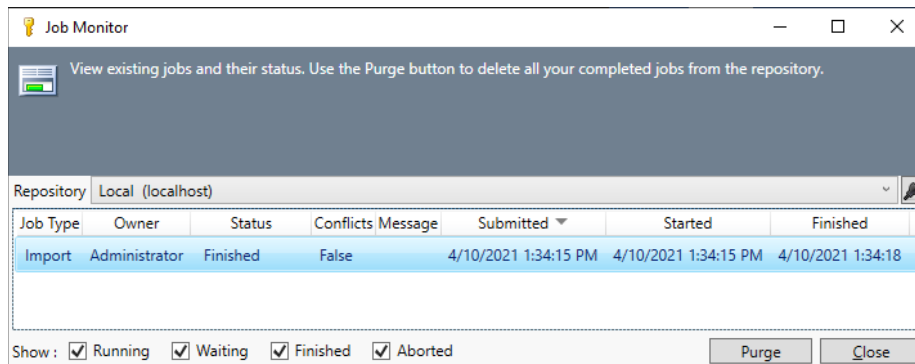

NOTE: Upon completion of the import, the word “False” will appear to indicate there were no conflicts.

8. When the import is complete, click **Close** to close the Job Monitor.

We will now open the imported project.

Systems Engineering Guided Tour

9. Select **SAMPLE: Geospatial Library** in the Project list.
10. Click **Open**.

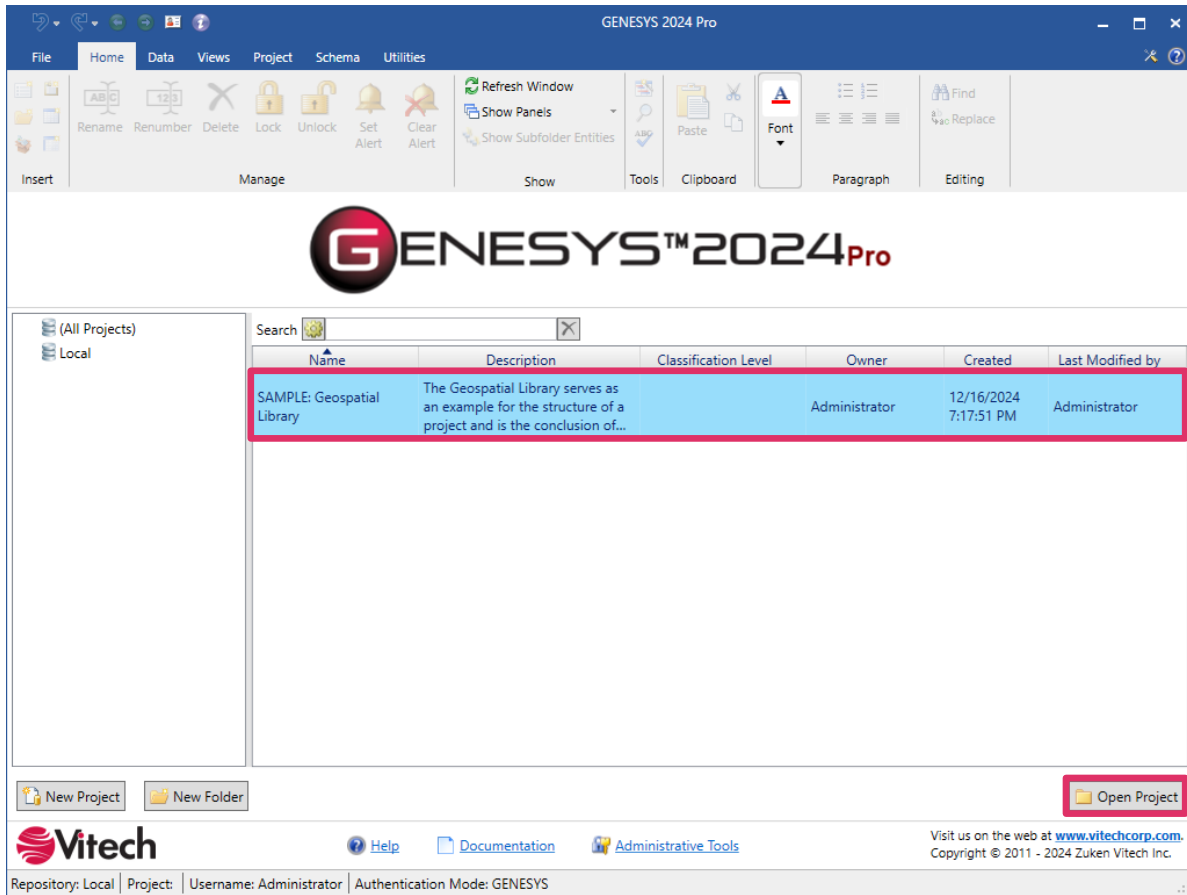

When the project opens, the *Project Explorer* pane that lists all of the items in the project displays on the left and the project properties display on the right.

Later in this guide, the items in the *Project Explorer* pane will be defined.

Systems Engineering Guided Tour

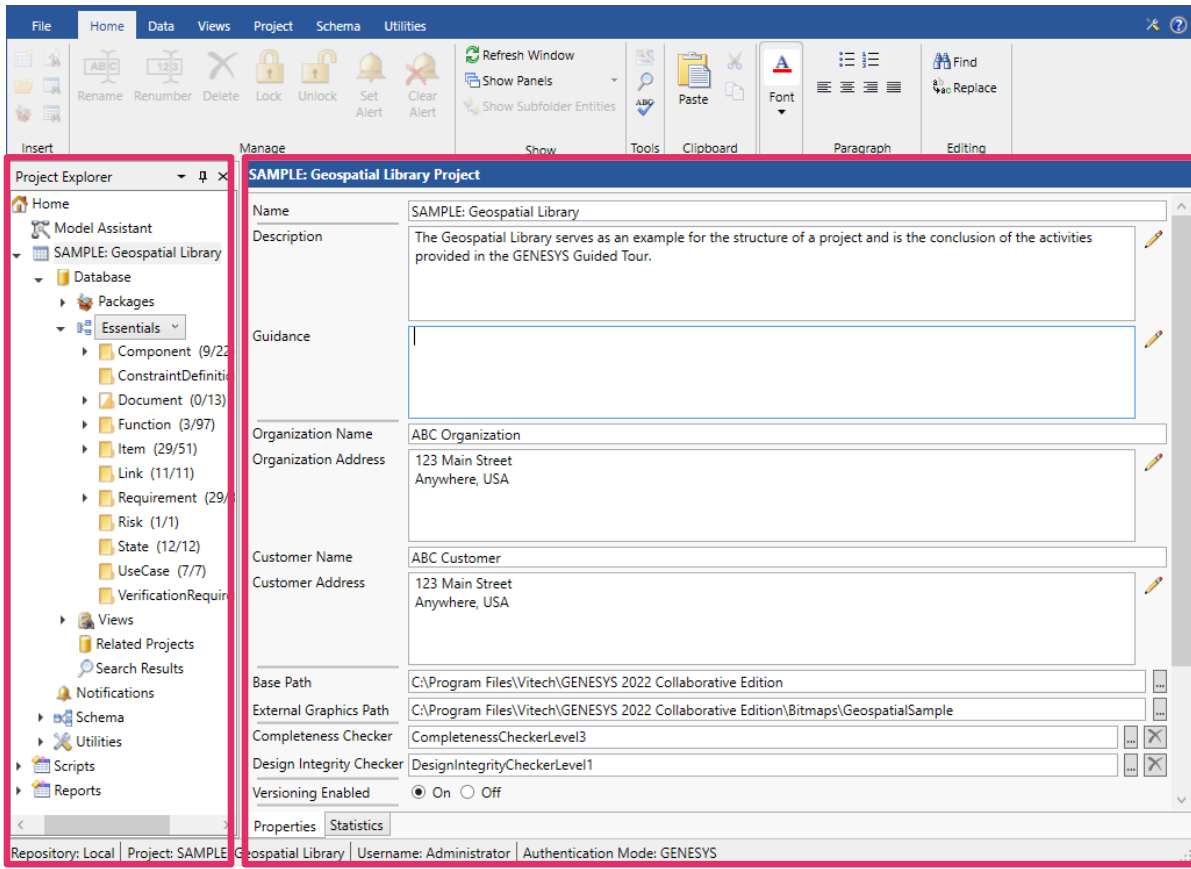

The project properties include:

- project name
- description
- guidance information
- organization name and address
- customer name and address
- base path where the application is stored
- external graphics path
- completeness checker script (selected from a drop-down menu accessed by clicking the **Browse** icon)
- design integrity checker script (selected from a drop-down menu accessed by clicking the **Browse** icon)
- versioning enabled/disabled
- audit logging turned on/off
- baseline schema version
- unique entity names true/false
- version number
- created by
- modified by
- ID

If you select the **Statistics** tab on the bottom of the screen, project statistics are displayed, as shown below.

Systems Engineering Guided Tour

The screenshot displays the 'SAMPLE: Geospatial Library Project' statistics window. The window is titled 'SAMPLE: Geospatial Library Project' and contains a table with the following data:

Entities	429
Relationships	878
Related Projects	0
Cross-Project Entities	0
Cross-Project Relationships	0
Cross-Project Entity References (Entity Attributes)	0
Cross-Project Entity References (Relationship Attributes)	0

The 'Statistics' tab is selected in the bottom navigation bar. The status bar at the bottom indicates: Repository: Local | Project: SAMPLE: Geospatial Library | Username: Administrator | Authentication Mode: GENESYS

Project statistics include:

- Number of entities in the project
- Number of relationships in the project
- Number of related projects
- Number of cross-project entities
- Number of cross-project relationships
- Number of cross-project entity references (entity attributes)
- Number of cross-project entity references (relationship attributes)

These statistics provide valuable information and insight on the size of a project (number of entities, relationships, etc.) and the degree of interconnectivity (cross-project entities, relationships, etc.) with other projects.

Systems Engineering Guided Tour

11. Click on the **Component** class in the *Project Explorer* pane.

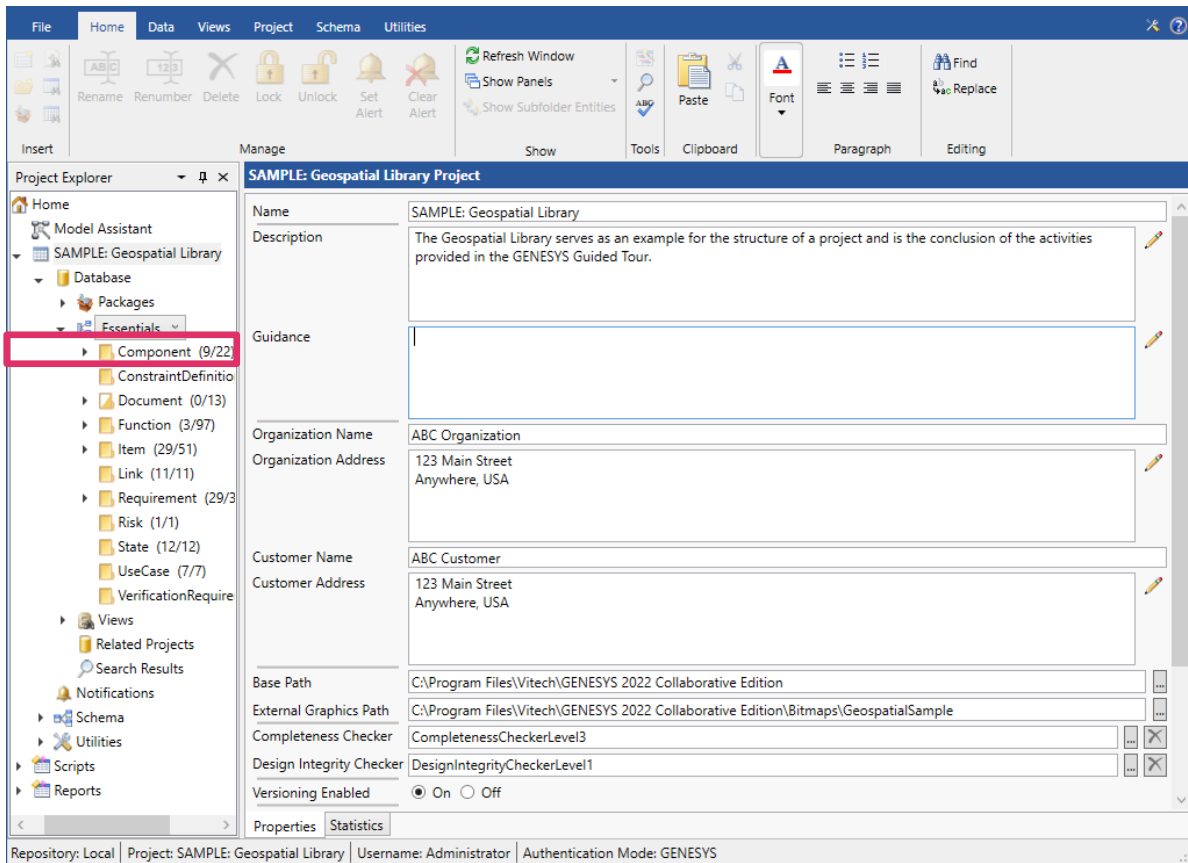

The Main GENESYS Window

The *Project Explorer* pane on the left lists the classes and folders in the system design repository. The main GENESYS window provides quick access to information contained in the system design repository for a particular project. Ribbons provide icons to access frequently used commands.

Systems Engineering Guided Tour

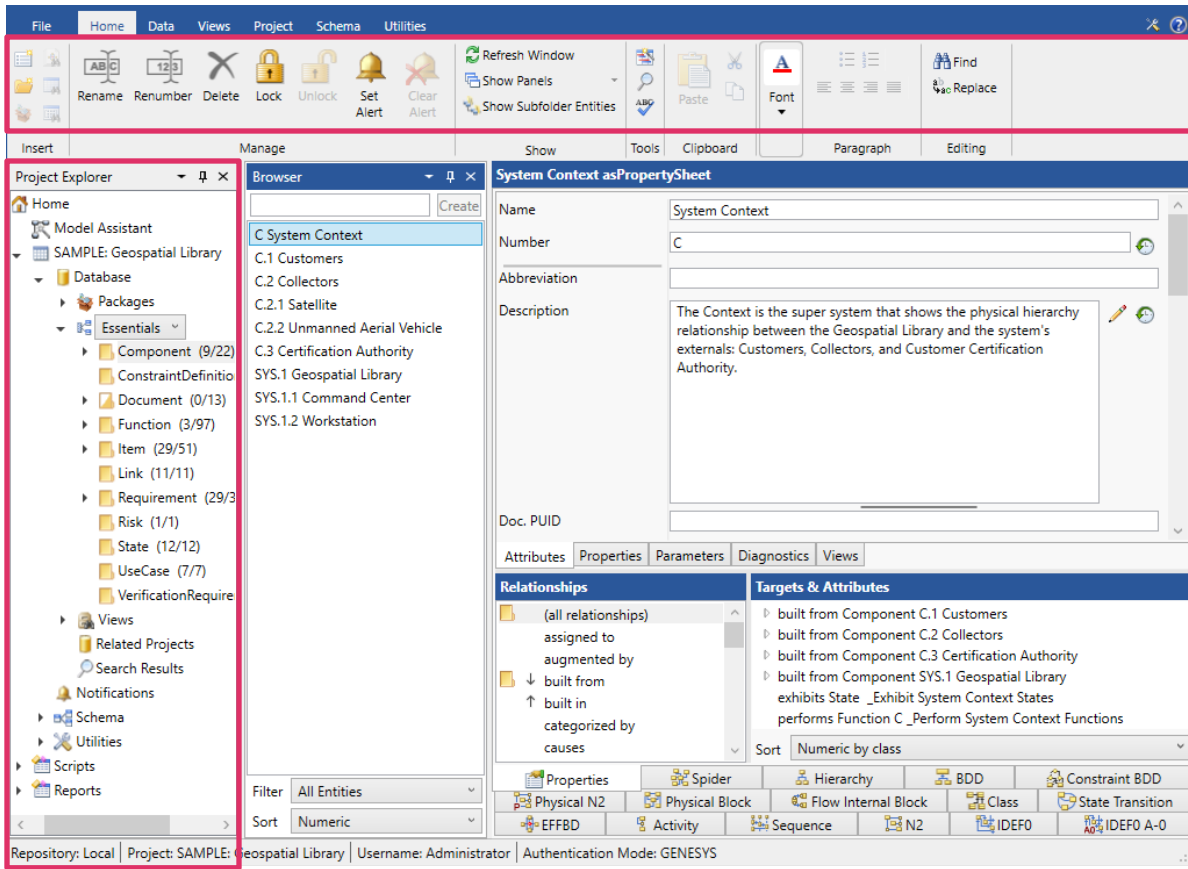

Browser

Selecting one of the classes/folders in the *Project Explorer* pane displays all that folder's entities in the *Browser* pane. In the Properties, you can view the structure of the data, create new entities, and update entities. A tan folder preceding the class name in the *Project Explorer* pane indicates that at least one entity (instance) of that class has been defined. The numbers in parentheses indicate how many entities have been defined for that folder and how many total entities are contained in that folder and all its subfolders.

Systems Engineering Guided Tour

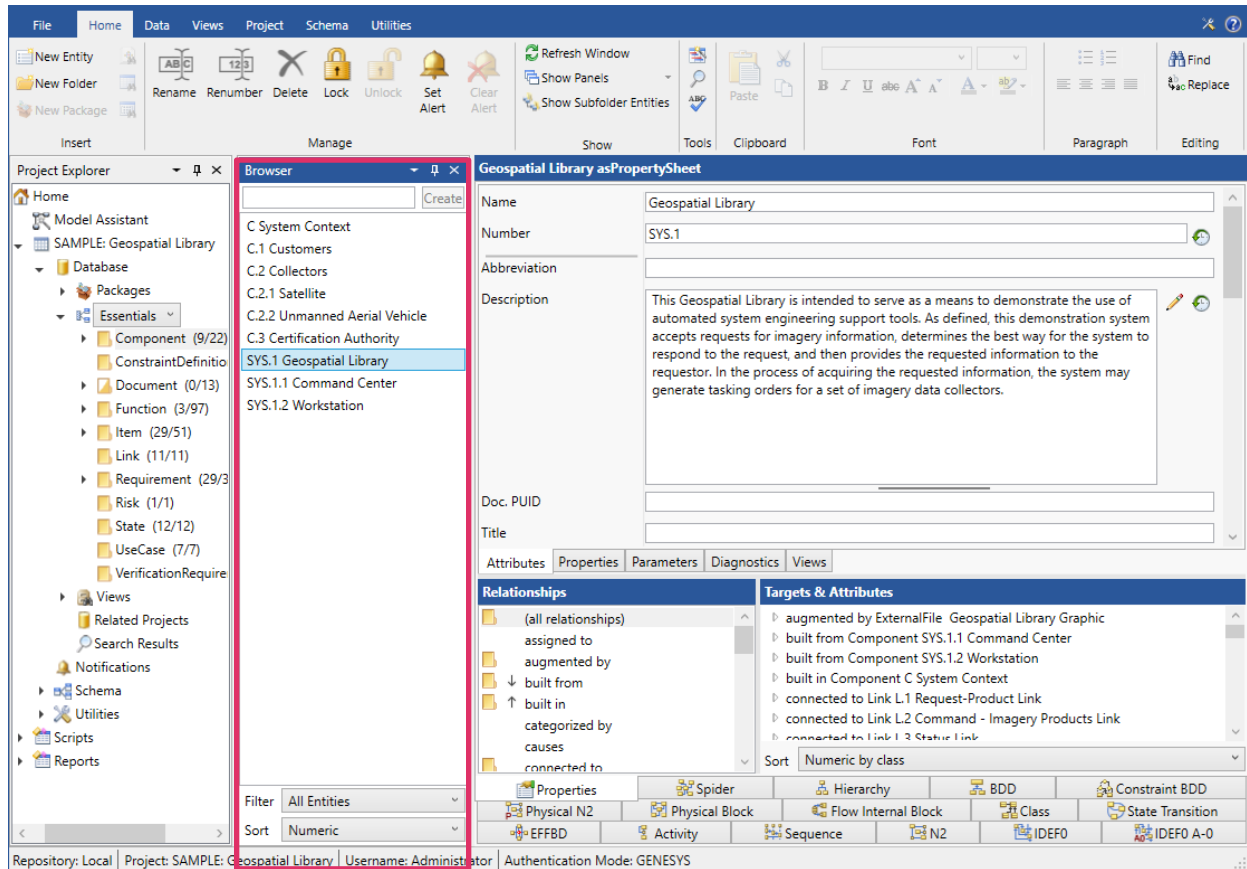

1. With the folder **Component** selected in the *Project Explorer* pane, select the **Component** named *Geospatial Library* in the *Browser* pane.

The property sheet for the **Component** will be populated. Notice that the bottom-right of the screen now displays a **Views** tab for the diagrams available for this class.

Systems Engineering Guided Tour

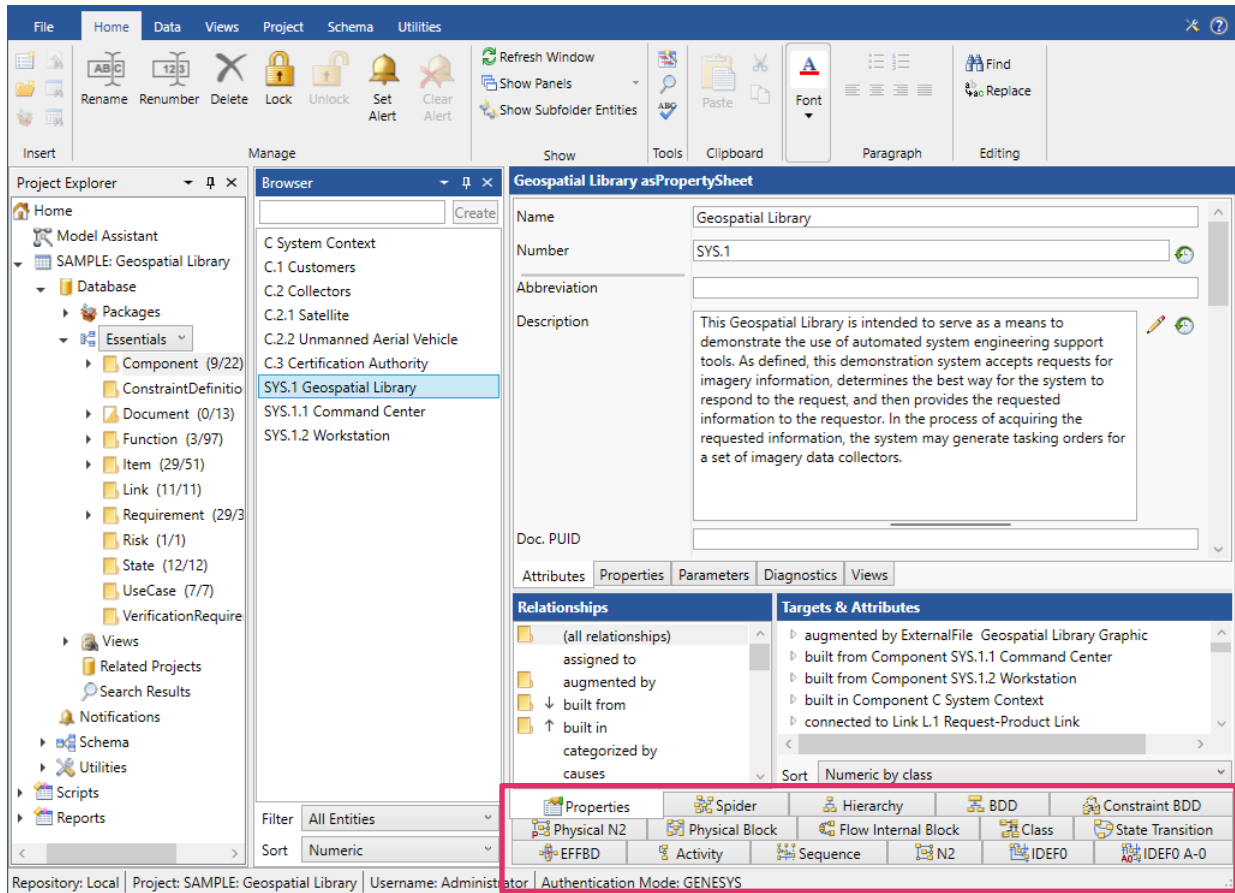

Model Assistant and Model Assistant Rules

The Model Assistant is on by default which is causing GENESYS to automatically display view tabs for the logical and physical views.

The Model Assistant is a convenient built-in tool in GENESYS that applies rules to the model to assist GENESYS users.

Some useful rules it applies to use cases and states (that will be discussed later) are described below. These rules enable users to easily flow through related concepts and levels of abstraction by further connecting behavior to use cases and states.

Use Case Rule Examples

The *Auto-Create Primary Function for Use Cases* rule, when enabled, automatically creates a primary function whenever a GENESYS user creates a use case or use case subclass. It also automatically creates an *elaborated by* relationship between the use case and the primary function.

The *Show Primary Function Views for Use Cases* rule, when enabled, directly opens logical and behavioral views for use cases and use case subclasses.

State Rule Examples

The *Auto-Create Root Function for States* rule, when enabled, creates a root function whenever a GENESYS user creates a state. It also automatically creates an *incorporates* relationship between the state and the root function.

Systems Engineering Guided Tour

The *Show Root Function Views for States* rule, when enabled, directly opens logical views for state and state subclasses.

To learn more about the Model Assistant, reference the Model Assistant screencast found in the GENESYS Screencast Archive on our website at <https://www.vitechcorp.com/genesys-screencasts-on-demand/>.

Entity Property Sheet

A property sheet provides the complete definition of a given entity in the system design repository by displaying all the attribute values, the system properties, the parameters, and the relationships. You can use the property sheet view corresponding to any entity to view, add, or make changes to the attributes and relationships of the displayed entity. The list of attributes and relationships differs depending on the class of the entity displayed. Here, we are looking at an entity of the **Component** class, so only those attributes and relationships that pertain to **Components** are displayed.

1. Open the property sheet as a separate window by double-clicking on the entity name – *Geospatial Library* in this case – in the *Browser* pane or, with the entity selected, click on the **Views** tab in the ribbon, then the **Properties** icon. 

The attributes and their values are displayed in the upper portion of the sheet. The relationships and targets that complete the entity definition are displayed in the lower portion of the window. Use the scrollbars on the right to view the complete list of attributes and relationships.

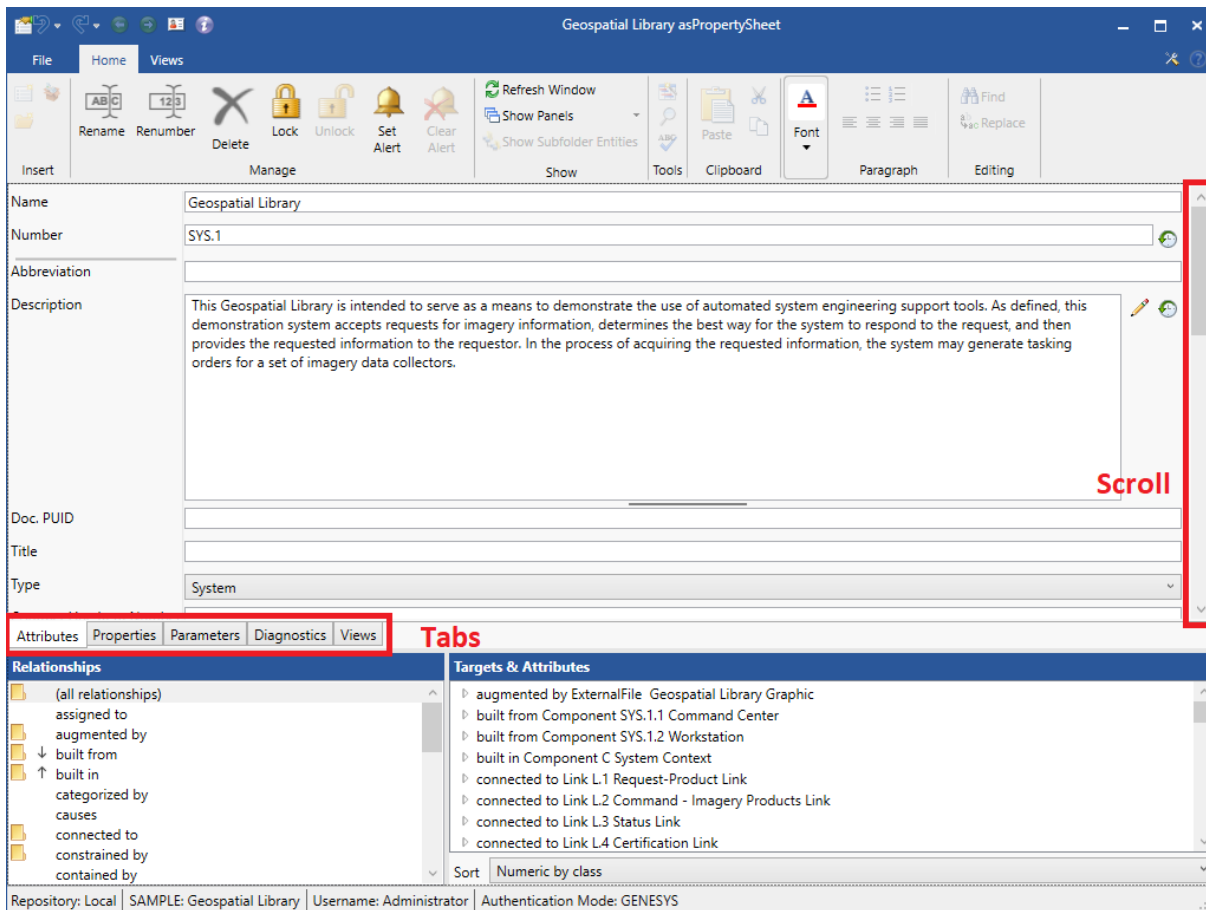

2. Scroll through the attributes. Attributes are shown on the **Attributes** tab. Additional detail can be found on the **Properties** tab, the **Parameters** tab, the **Diagnostics** tab, and the **Views** tab.

Systems Engineering Guided Tour

3. Scroll through the list of possible relationships. A folder in front of a relationship indicates that a target has been established for the relationship. The down arrow indicates that the relation is to children entities. The up arrow indicates that the relation is to parent entities.
4. In the list of relationships, click on *built from*. The expand arrow in front of the target indicates that the relationship has an attribute. Use the expand arrow to collapse/expand the list.

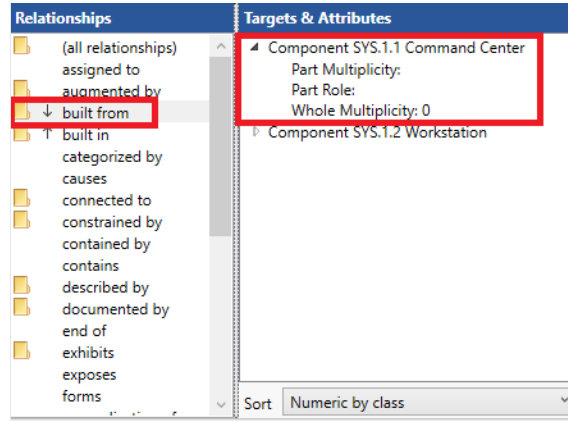

5. Close the property sheet.

Accessing a Graphical View

You can directly access the entity views by selecting the view tabs at the bottom of the property sheet, the *Views* ribbon icons, or the **Open Entity** command in the right-click menu of the *Browser* pane. Selecting the bottom view tabs opens the view within the main window. To create more room for a tabbed view, you can stack the *Project Explorer* and *Browser* panes by dragging one on top of the other. Clicking an icon on the *Views* ribbon opens the view in a separate window.

NOTE: The steps below assume a GENESYS Pro license. If you have a GENESYS license and the specific view is not accessible, you can view a different diagram on a **Component** entity for this step. For future occurrences, you'll see a note accompanied by information for GENESYS users.

Let's look at an example. A Block Definition Diagram (BDD) represents the composition structure of systems, **Components**, **Items**, conceptual entities, and logical abstractions. Part of the physical architecture representation set, this is like a traditional physical hierarchy with select semantic and representational differences. Most notably, the BDD can optionally indicate the role that the part plays regarding its parent.

1. Select *Geospatial Library* from the list of entities in the **Component** class.
2. In the view tabs along the bottom of the screen, click the **BDD** tab  to display the BDD of the entity (or click the equivalent icon in the ribbon to open the view in a separate window).

NOTE: Throughout the guided tour, we will often open a separate view to enhance the readability of the view contents in this document. Where this occurs, you can display the view in the main window by clicking the corresponding view tab (in the case of hierarchy diagrams, you must also select the type of hierarchy from the drop-down menu). Once the view is displayed, the step-by-step instructions to modify the view will still apply.

The Toolbox (on the right-hand side of the diagram) is available to manage the diagram. By selecting a Construct and dragging it to the desired position on the diagram, it can be added to the view.



By selecting the **Key Entities** icon, classes and entities that can be added to the view are displayed. Using drag-drop will add the selected entity.

Systems Engineering Guided Tour



By selecting the **All Entities** icon, all classes and entities are available and can be related to any entity in the view using drag-drop. Any action using the Toolbox will also update the underlying data model.

If you opened a separate window to view the BDD, please close it now.

Saving GENESYS Data

Saving Data in the Local or Server Repository

Data in your local repository is saved in an instance of SQL Server Express on your local machine. Data is committed as you create it. No further save actions are required to commit your data. Vitech recommends following your organization's backup procedures to further ensure the security of your data.

Saving Data to a GENESYS Server

GENESYS Server is built on the full version of SQL Server. Like saving data in your local repository, data is committed as you create it. Your organization's backup procedures should be followed to further ensure the security of your data.

Saving Data to GNSX

GNSX is the GENESYS data format that is used for export/import, backup, and data exchange. This provides "single file" storage for all project data: multiple projects, schema, stored views, sort blocks, hierarchy definitions, filters, etc.

To save your data to a GNSX file:

1. Select the **File Menu > Export**.

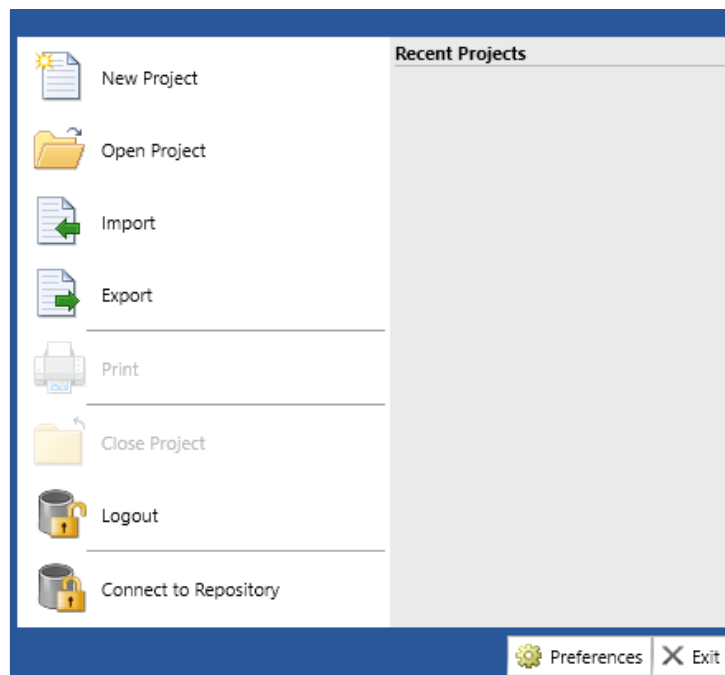

An Export Options dialog will open.

Systems Engineering Guided Tour

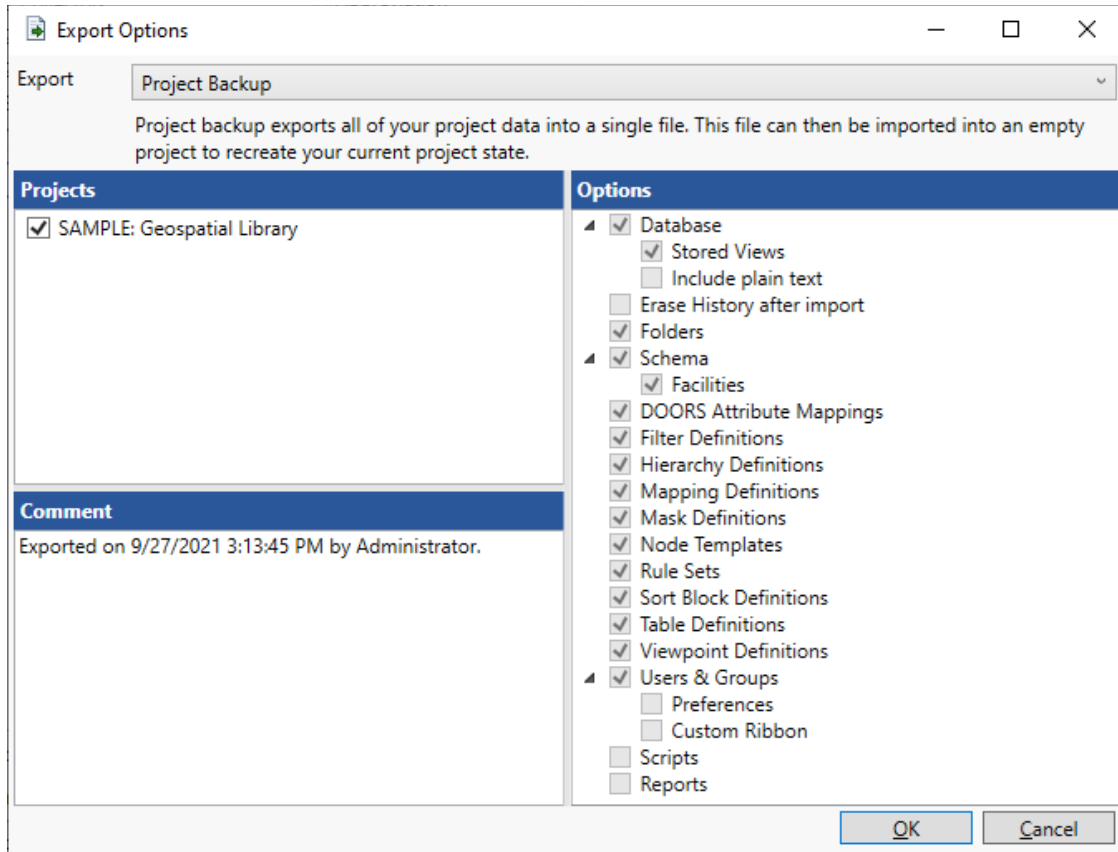

2. Click **OK**, since we will use the default settings to export the entire project.

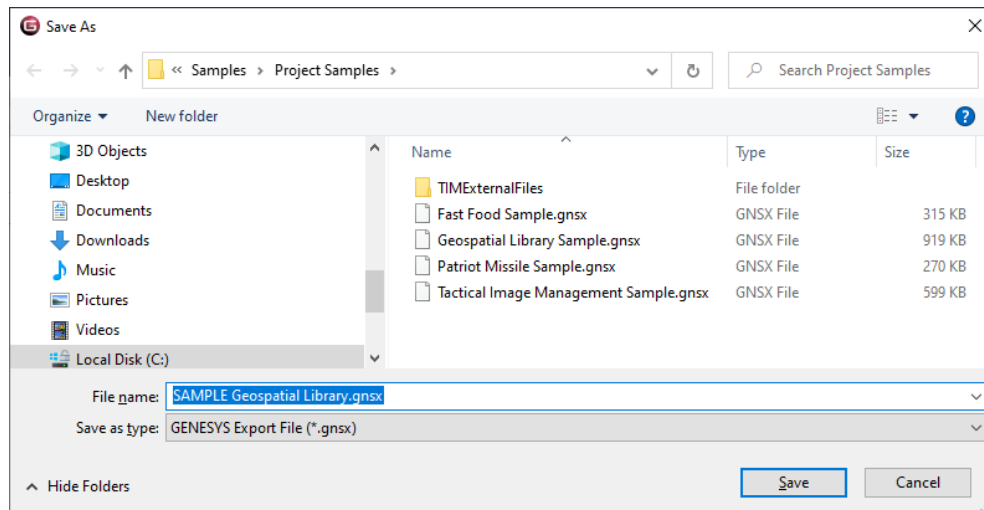

3. When the Save As dialog appears, name the export file *Geospatial Library.gnsx* and select the desired save location.
4. Click **Save**. The Job Monitor indicates the progress of the export.
5. Click **Close** in the Job Monitor when the export is complete.
6. Close the *Geospatial Library* model by clicking on the **File Menu** and then clicking **Close Project**.

Systems Engineering Guided Tour

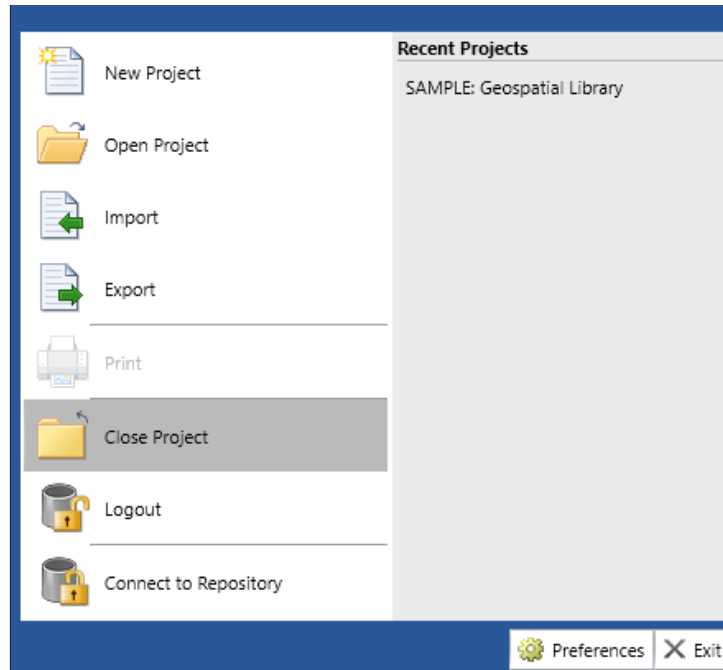

Importing a Package

To import a package into GENESYS:

1. Select **File > Import**.

The Import Wizard appears.

NOTE: A package has a .gnsx file extension. It is created by exporting a package/project from GENESYS.

The GENESYS smart import feature detects the type of file/package being imported and displays the appropriate import options for that file/package.

2. For a package, at the **Scenario** drop-down list that appears at the top of the Import Wizard, select the import method (*Load Package* or *Instantiate Model Segment*).

Systems Engineering Guided Tour

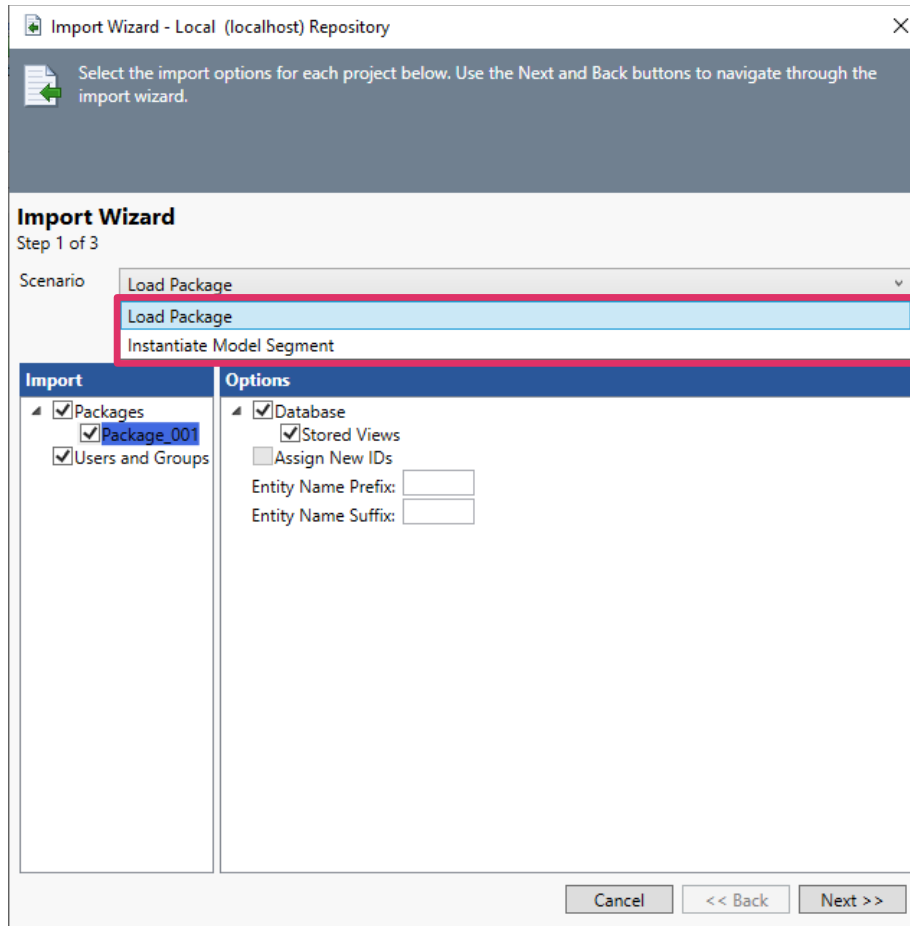

To assist the GENESYS user in selecting the appropriate import method, a description of the option appears on the window when they select one of the options.

Systems Engineering Guided Tour

Import Wizard - Local (localhost) Repository

Select the import options for each project below. Use the Next and Back buttons to navigate through the import wizard.

Import Wizard

Step 1 of 3

Scenario: Load Package

Load package imports all package content without modifying the entity IDs or names by default. This supports model management via packages.

Import	Options
<input checked="" type="checkbox"/> Packages	<input checked="" type="checkbox"/> Database
<input checked="" type="checkbox"/> Package_001	<input checked="" type="checkbox"/> Stored Views
<input checked="" type="checkbox"/> Users and Groups	<input type="checkbox"/> Assign New IDs
	Entity Name Prefix: <input type="text"/>
	Entity Name Suffix: <input type="text"/>

Buttons: Cancel, << Back, Next >>

The *Load Package* option imports all package content without modifying the entity IDs or names. This method supports model management through packages.

Systems Engineering Guided Tour

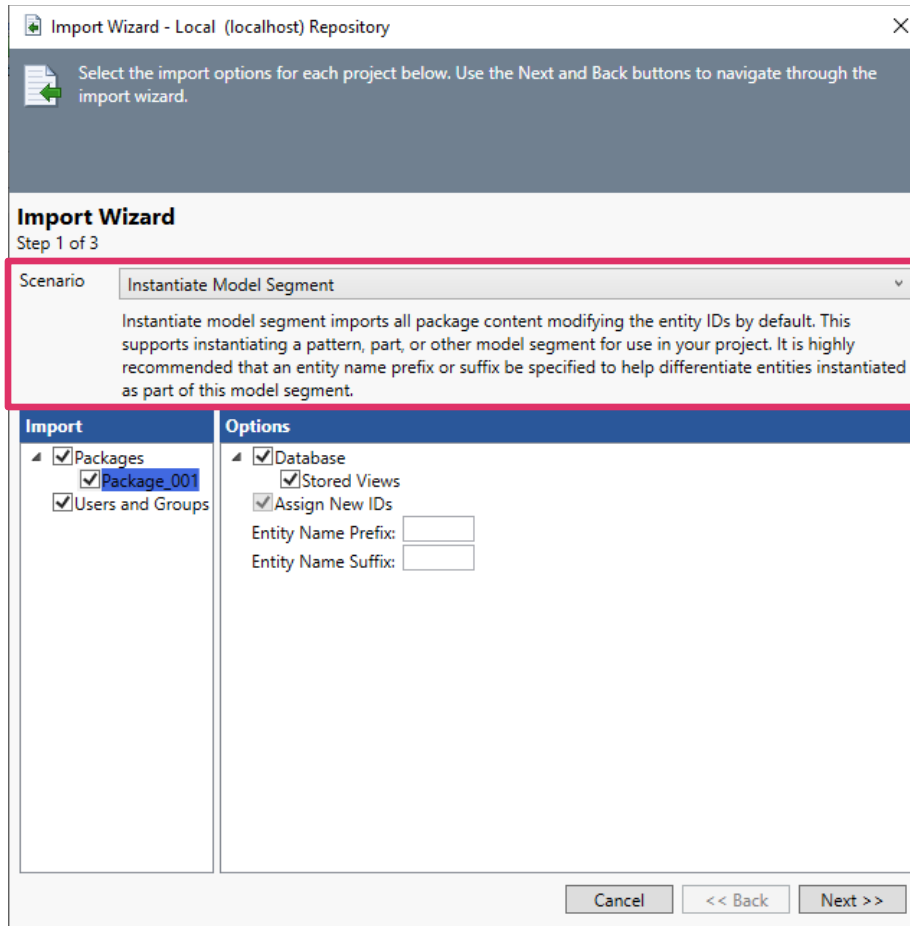

The *Instantiate Model Segment* option imports all package content and modifies the entity IDs. This method supports instantiating a pattern, part, or other model segment for use in a GENESYS project. It is highly recommended that users specify an entity name prefix or suffix to differentiate entities instantiated as part of this model segment.

Load Package is the default method.

3. After selecting the import method, click **Next**.

Systems Engineering Guided Tour

Import Wizard - Local (localhost) Repository

Select the import options for each project below. Use the Next and Back buttons to navigate through the import wizard.

Import Wizard
Step 2 of 3

Package: Package_001

Create New Project: Maze Chase

Import Into Project: [Dropdown]

Cancel << Back Next >>

4. Select *Create New Project* or *Import into Project* and click **Next**.

Systems Engineering Guided Tour

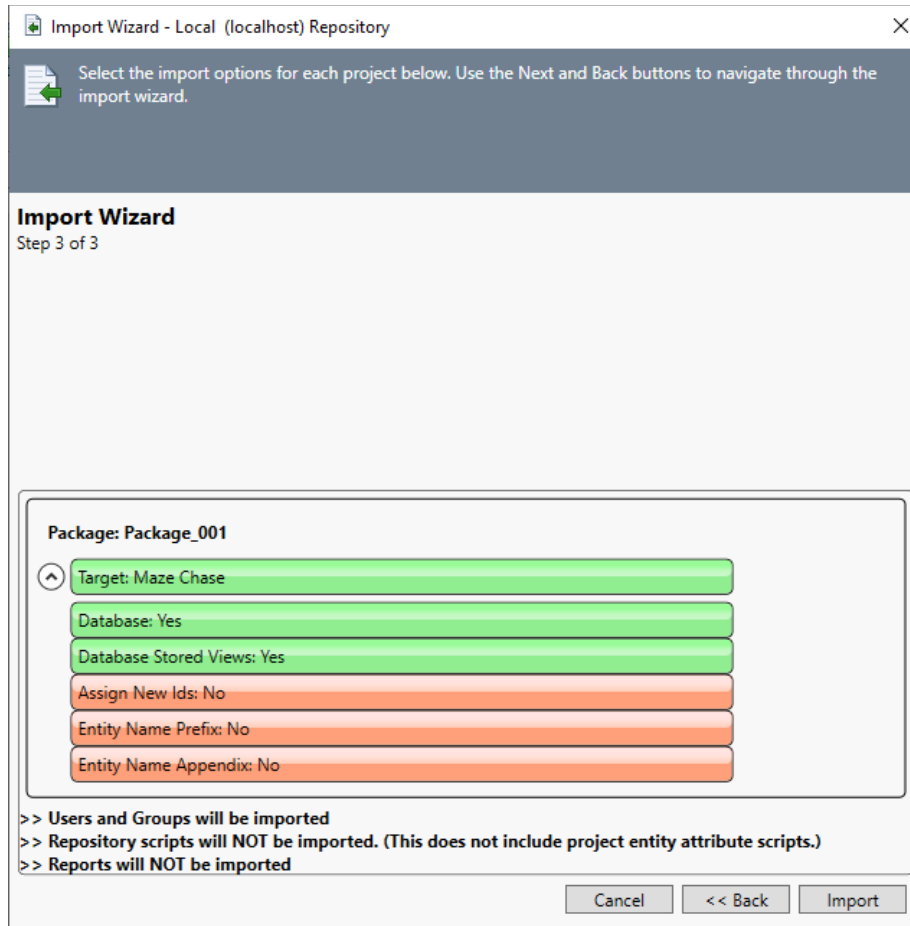

The third wizard screen displays the selected options for import.

5. Click **Import** to begin importing the package.

The Job Monitor window displays.

Systems Engineering Guided Tour

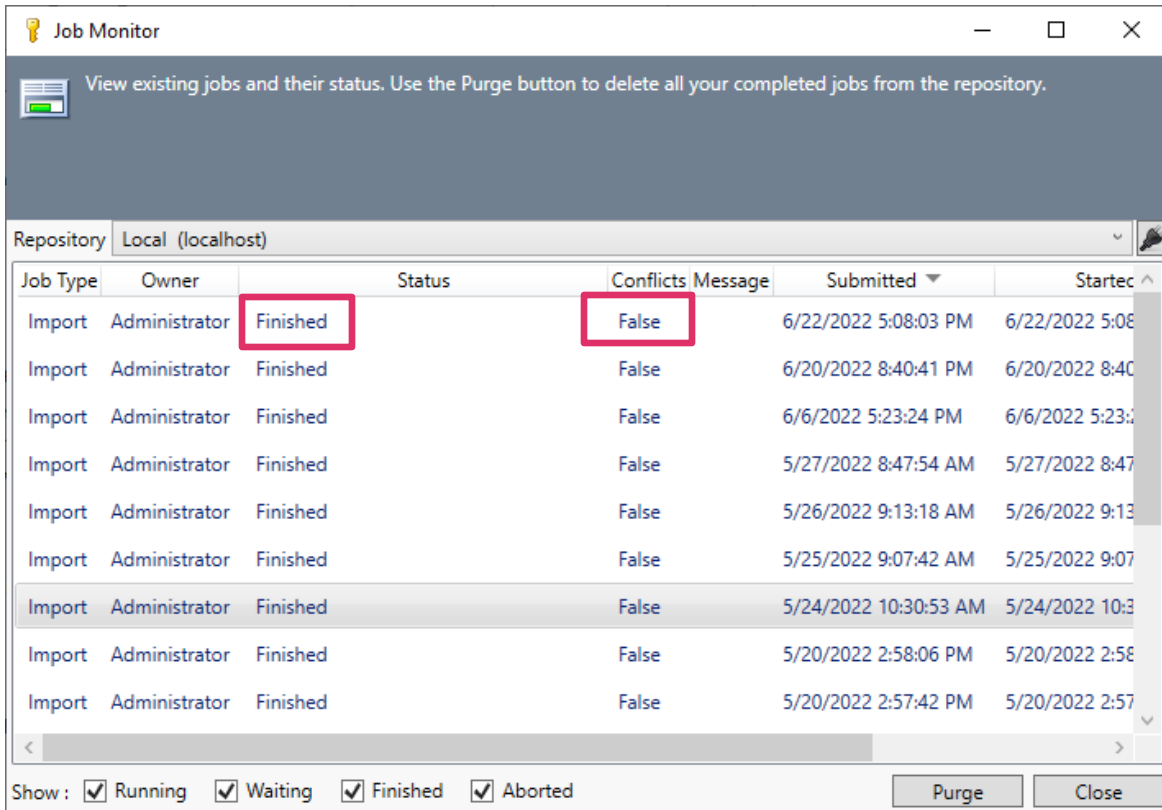

Job Monitor

View existing jobs and their status. Use the Purge button to delete all your completed jobs from the repository.

Repository: Local (localhost)

Job Type	Owner	Status	Conflicts	Message	Submitted	Startec
Import	Administrator	Finished	False		6/22/2022 5:08:03 PM	6/22/2022 5:08:03 PM
Import	Administrator	Finished	False		6/20/2022 8:40:41 PM	6/20/2022 8:40:41 PM
Import	Administrator	Finished	False		6/6/2022 5:23:24 PM	6/6/2022 5:23:24 PM
Import	Administrator	Finished	False		5/27/2022 8:47:54 AM	5/27/2022 8:47:54 AM
Import	Administrator	Finished	False		5/26/2022 9:13:18 AM	5/26/2022 9:13:18 AM
Import	Administrator	Finished	False		5/25/2022 9:07:42 AM	5/25/2022 9:07:42 AM
Import	Administrator	Finished	False		5/24/2022 10:30:53 AM	5/24/2022 10:30:53 AM
Import	Administrator	Finished	False		5/20/2022 2:58:06 PM	5/20/2022 2:58:06 PM
Import	Administrator	Finished	False		5/20/2022 2:57:42 PM	5/20/2022 2:57:42 PM

Show: Running Waiting Finished Aborted

Purge Close

The third column on the Job Monitor indicates *Finished* if the import has completed.

The fifth column on the Job Monitor states *True* or *False* to indicate if any conflicts occurred during the import process.

3. STARTING A GENESYS PROJECT

This section covers the beginning steps in working with requirements:

- Introduce the Guided Tour's user exercise
- Extract requirements into GENESYS
- View the requirement hierarchy
- Use the diagram toolbox

The Sample Problem: Geospatial Library

In the rest of the guided tour, you will use GENESYS and several of its features by systematically building the sample design for the Geospatial Library. Please review the Geospatial Library context diagram and its description as found in Section The Sample Problem: Geospatial Library. You may find it helpful to refer to this diagram as you build the system structure.

Summary of the Typical Top-down Process

GENESYS supports top-down, bottom-up (reverse), and middle-out engineering processes / paradigms. For this guided tour, we are using a top-down approach assuming the Geospatial Library is an unprecedented system. We will begin by extracting our source requirements using the GENESYS Document Parser. We will then analyze and refine our source requirements. After analyzing the requirements, we will define our system boundary and capture the physical architecture constraints. Finally,

Systems Engineering Guided Tour

we will derive the system behavior and extend the physical architecture, allowing us to allocate the behavior to the appropriate system components.

The CSDL characterizes the stakeholder and system requirements in the system design repository by capturing each requirement's relationships and attributes. The developing system design model is concurrently analyzed by the design team for "fitness" as a solution, identifying any inherent design impediments, while checking the model for consistency and completeness. While the functional behavior definition is proceeding, the physical decomposition of the system is specified so that the behavior can be allocated to the physical system components responsible for performing the functions. One result of this allocation is the definition of all interfaces between the physical entities of the system, including hardware, software, and people. We will complete the following steps in this guided tour:

1. Capture the source document, often a starting point for top-down engineering.
2. Capture the requirements from the source documentation.
3. Define the system and its boundary.
4. Derive the system behavior while extending the physical architecture and allocating all behavior to the physical architecture.

After completing this, we will have established traceability among the relevant design entities, identified and resolved critical concerns, and provided documentation.

Capturing the Problem and Source Requirements

In Section 2, we learned how to import and view an established project file. Now we will begin building our model in GENESYS, starting with an empty project.

To create a new project:

- Click the **File Menu** and select **New Project.**, or click **New Project** on the GENESYS Home page or in **Administrative Tools** under the **Projects** tab.
- Name your project **My Guided Tour Work**.
- Accept all other default settings and click **OK**.

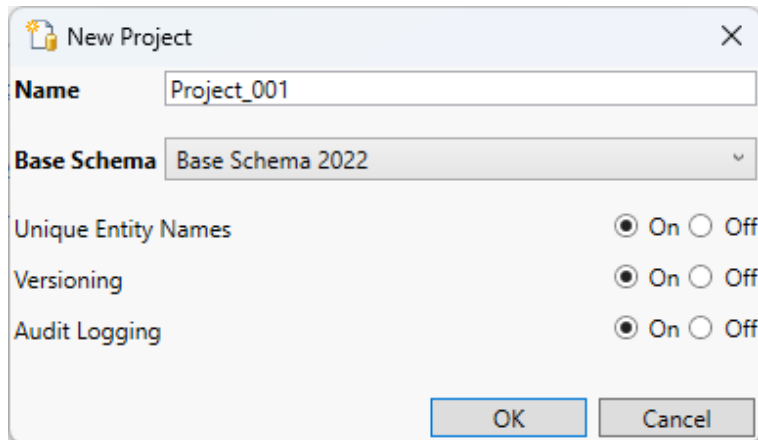

Your project will be created and will automatically open when project creation is complete. With the project open you can fill in basic information like names (Organization/Customer) and addresses.

Systems Engineering Guided Tour

My Guided Tour Work Project	
Name	My Guided Tour Work
Description	
Guidance	
Organization Name	Your Org
Organization Address	## Street City, ST zip
Customer Name	Your Customer's Name
Customer Address	Your Customer's Address
Base Path	
External Graphics Path	
Completeness Checker	CompletenessCheckerLevel3
Design Integrity Checker	(none)

Loading the Source Document

We will start by using the Document Parser to capture the relevant information from the source document and import it into your new GENESYS project. To do this:

1. Under the *Utilities* ribbon, click the **Document Parser** icon.

Systems Engineering Guided Tour

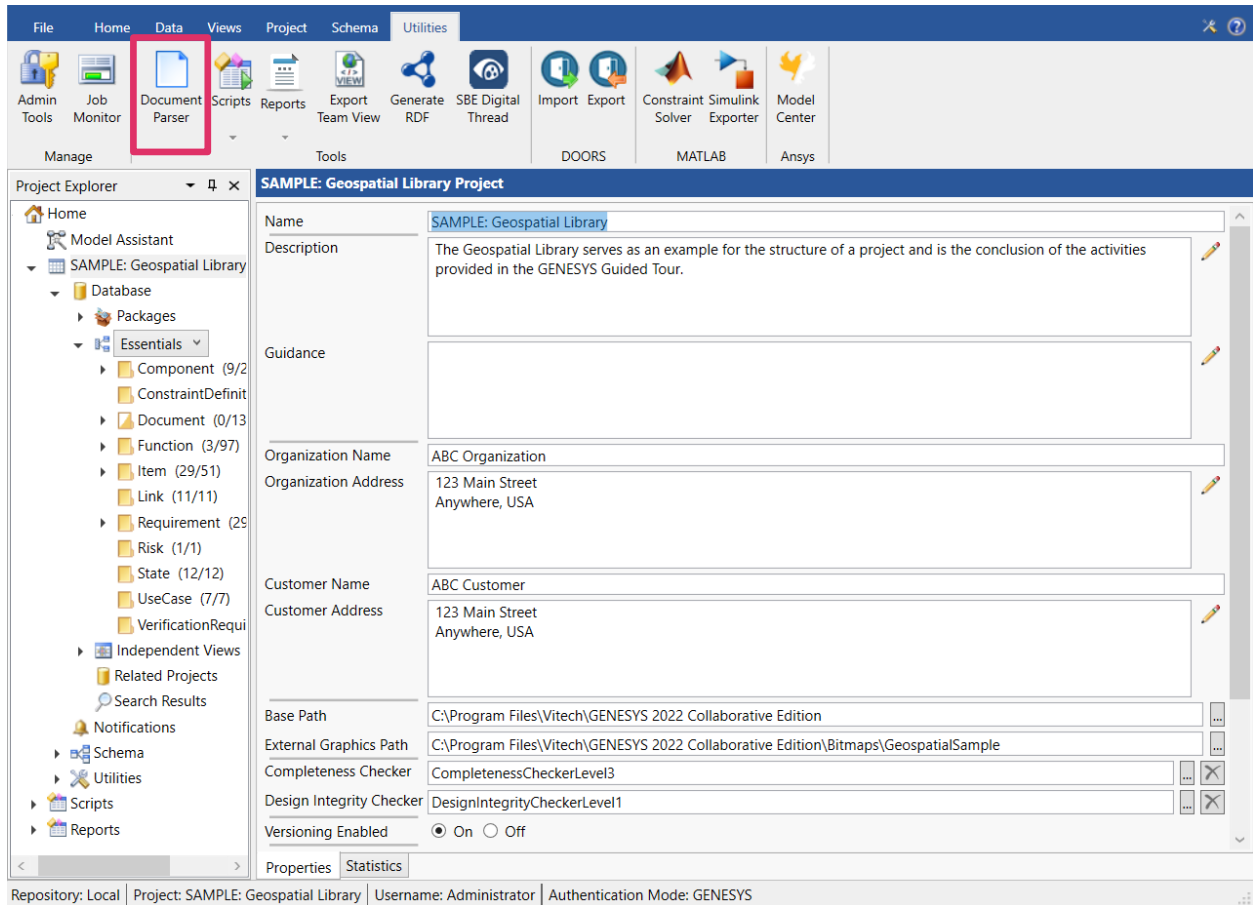

Once the Document Parser opens, we will browse for the source document.

The source document must be a DOCX, DOC, HTM, HTML, RTF, or TXT file. To load your source document:

Click on the **Load Document** icon on the ribbon.

We will use the file *GeospatialLibrarySourceDocument.doc*,  located in the *GENESYS 2024\Samples\Project Samples* folder.

2. Navigate to the *\Program Files\Vitech\GENESYS 2024\Samples\Project Samples* folder.
3. Select *GeospatialLibrarySourceDocument.doc*.
4. Click **Open**.
5. Next identify the source document that will be parsed by clicking **Select** in the bottom-right of the Document Parser.

Systems Engineering Guided Tour

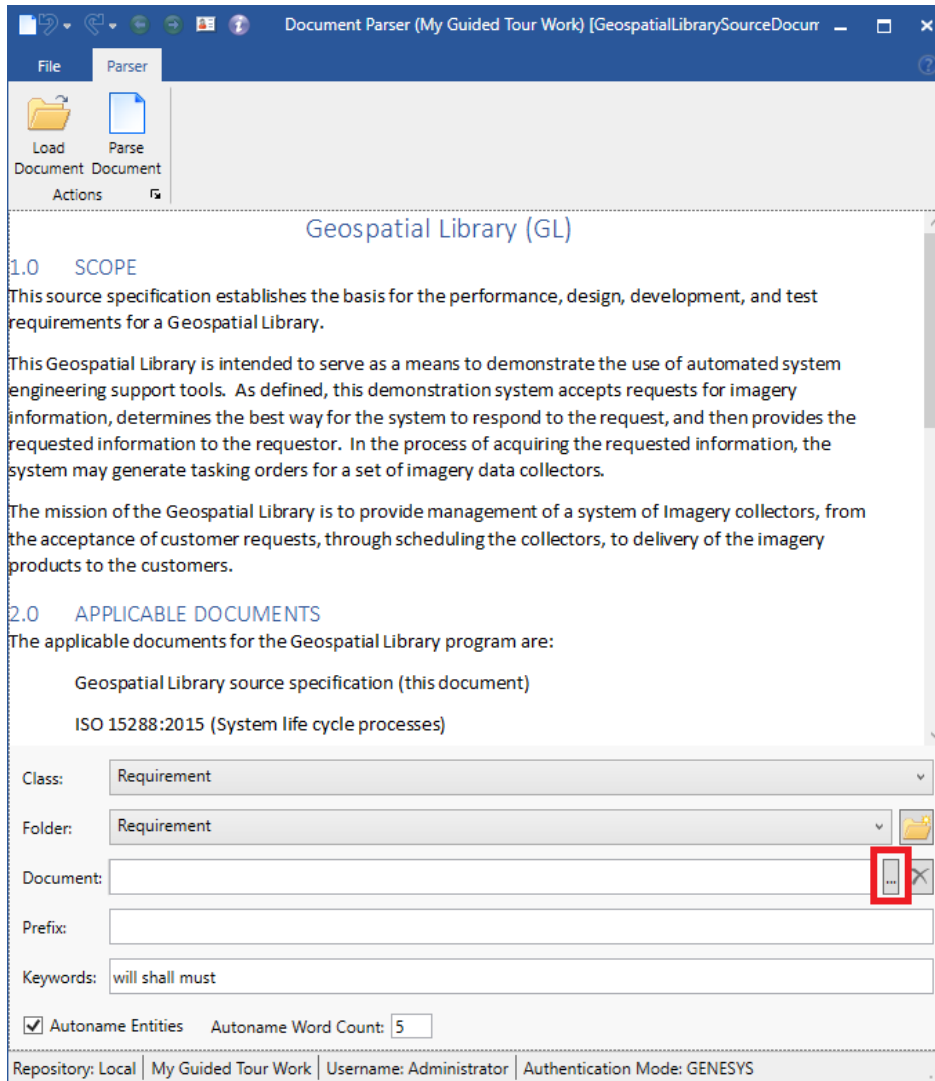

Since this is a new project, there are currently no document entities in our model. We will create a document entity to represent our source document (this will later provide traceability from the source document to the imported requirements). To do this:

6. On the Document line, click the **Select** button.
7. Select **New** to enter a new document.
8. Enter **GL Source Document** then click **OK**.
9. Click **OK** one more time to close the dialog.

We can enter a prefix that can be used for all the entities created. We are not going to do so for this example.

We will identify the keywords that will be used in parsing the document. The Keywords field is auto populated by default with the most common keywords used to indicate a **Requirement**. Additional keywords may be added or deleted by the user.

Finally, we can let the parser auto-name the entities using the words following the first keyword found.

Parsing the Document

The *GeospatialLibrarySourceDocument.docx* file displays in the center pane of the Document Parser.

Systems Engineering Guided Tour

The Document Parser can extract text into any class of entities. The **Requirement** class is pre-selected, as it is the most common destination class for parsed data.

If you wish to further organize your data, you can add a sub-folder under the **Requirement** class, and then add your requirements to the sub-folder as needed. In this instance, we will leave the folder structure as is.



Select the **Parse Document** icon located on the ribbon.

The Parser will parse the entire document's statements (or sentences) into the project. Statements that contain one of the keywords are named with the word "Requirements" and a number. Others are loosely termed "debris" and may include boilerplate text or other valuable content, which we will assess later. Where possible, the parser identifies attributes and creates the *refines* relationship for an entity when a hierarchy is identified.

10. Close the Document Parser.

Identifying Other Entities

Our next step is to identify other useful statements that were imported with the Requirements and transform them to the appropriate class.

11. In the *Project Explorer* pane, select the **Requirement** class.

The screenshot shows the Systems Engineering software interface. The 'Project Explorer' pane on the left is expanded to show the 'Requirement' class, which is highlighted with a red box. The 'Browser' pane in the center shows a list of requirements, including 'R.1 Continuous Support and Avail.', 'R.1.1 Continuous Support', 'R.1.2 Availability', 'R.2 Specific Requirements', and 'R.2.1 Accept Requests from Certifi'. The 'Availability asPropertySheet' pane on the right shows the details for the selected requirement, including its name 'Availability', number 'R.1.2', and description 'The system shall be unavailable no more than a total of 10 minutes per month.' The 'Relationships' and 'Targets & Attributes' panes at the bottom right show the relationships between the requirement and other entities in the project.

The Document Parser imported the entities into the **Requirement** class.

Systems Engineering Guided Tour

One of the requirements contains a description of the Geospatial Library and would better serve as a basic entity for constructing a **Component** entity representing our System of Interest.

To transform an entity from one class to another:

1. Select the requirement that you want to transform.
2. Click on the *Data* ribbon.
3. Select **Transform Class** command.
4. Select the **Component** class from the drop-down options.
5. The following dialog will appear. Select **OK** to confirm.

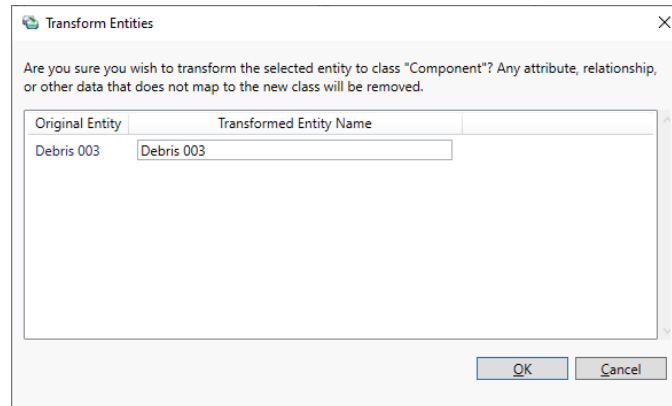

6. Click on the **Component** class in the *Project Explorer* pane.
7. Select the entity that you are transforming.

The property sheet of that entity will display. Let's complete the definition of this entity.

8. Click in the **Name** field and replace the current text with *Geospatial Library*.
9. Set the **Type** attribute to *System* using the drop-down selection list.

There is another entity in the **Requirement** class that contains information to help us further define our Geospatial Library component.

10. Switch back to the **Requirement** class and select that entity.
11. Highlight the text in the **Description** field, right-click and select **Copy**.
12. Switch back to the **Component** class and select the *Geospatial Library* entity.
13. Right-click in the **Mission** field and select **Paste**. (On some monitors, you may need to scroll down in the property sheet to locate the **Mission** attribute.)

Defining a Relationship

For a complete model, we must establish relationships between various entities to ensure full system and lifecycle traceability. The Document Parser automatically established a **Requirement** hierarchy by creating the *refines* relationships between the **Requirements** imported from the Source Document. The Document Parser also created the *documented by* relationship between the top-level **Requirements** and the GL Source Document entity.

The following step will establish a *documented by* relationship between the **Component** Geospatial Library and the GL Source Document entity.

Systems Engineering Guided Tour

1. Double-click the *documented by* relation in the *Relationships* pane (or select the relationship and select *Edit Targets* from the right-click menu) to open an Edit Targets dialog for the relationship.

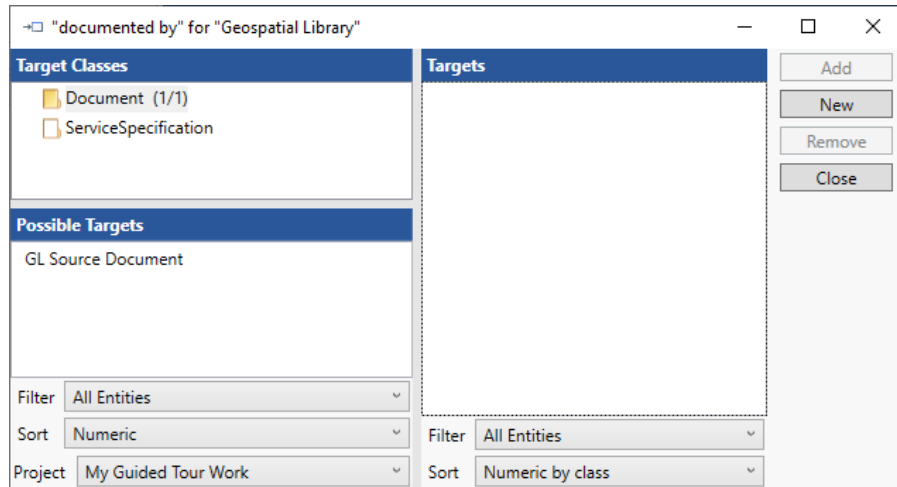

The Edit Targets dialog is used to add one or more targets to the selected relationship (or to remove targets from the selected relationship).

2. Select the **Document** class.
3. Select the *GL Source Document* entity in the *Possible Targets* pane.
4. Click **Add**, then **Close**.

The remaining **Requirements** should be reviewed to see what other useful information has been captured.

The Document Parser created a numbering scheme from the paragraph numbers contained in the Source Document. Although it named our requirements entities, we need to fix these names to be meaningful when viewed in a list.

5. Select the **Requirement** class.
6. Select entity *4.1 Accept Information Requests From Certified*.
7. Click in the **Name** field.
8. Replace the current text with *Accept Requests*.
9. Repeat this process to rename all the requirements as outlined in the following table.

Number	Name
4.0	Specific Requirements
4.1	Accept Requests
4.2	Retain Inventory and Provide Products
4.3	Control Multiple Collectors and Collector Types
4.4	Maximum Staff

Systems Engineering Guided Tour

4.5	Provide Feedback
4.6	Prioritize Requests
4.7	Monitor and Assess Performance

Notice the General Requirements at the bottom of your **Requirements** list. For consistency, we need to rename and renumber two of these requirements.

10. Rename Requirement 3.1 *Provide Continuous Real-time Support* to *Continuous Support*.

11. Rename 3.2 *Be Unavailable No More Than* to *Availability*.

This concludes the review of the entities created by the Document Parser. We can now delete the unused entities using the following method:

12. Using the **CTRL + Click** method, multi-select all the remaining requirements (from the top of the list), Scope, and Applicable Documents.

13. Click the **Delete** icon in the ribbon.



14. Click **Yes** when prompted to confirm the deletion.

The following shows the resulting list of requirements in the *Browser* pane.

- 3.0 Operations
- 3.1 Continuous Support
- 3.2 Availability
- 4.0 Specific Requirements
- 4.1 Accept Requests
- 4.2 Retain Inventory and Provide Products
- 4.3 Control Multiple Collectors and Collector Types
- 4.4 Maximum Staff
- 4.5 Provide Feedback
- 4.6 Prioritize Requests
- 4.7 Monitor And Assess Performance

Extracting the Child-Level Originating Requirements

Many of the captured **Requirements** are compound statements. Because an effective requirement should only contain one “shall” statement, we will break out the compound statements into child-level functional **Requirements**. Each child **Requirement** will relate to its parent requirement using the *refines* relationship. Traceability back to the source document, GL Source Document, is achieved through the parent requirement (as defined with the *documented by* relationship).

In GENESYS, the **Duplicate** command will allow you to create a copy of an entity, causing the new entity to inherit the attributes of the original entity, which is particularly useful when creating child-level requirements.

1. Select 4.2 *Retain Inventory and Provide Products*.
2. Right-click on the entity and click **Duplicate**.

Systems Engineering Guided Tour

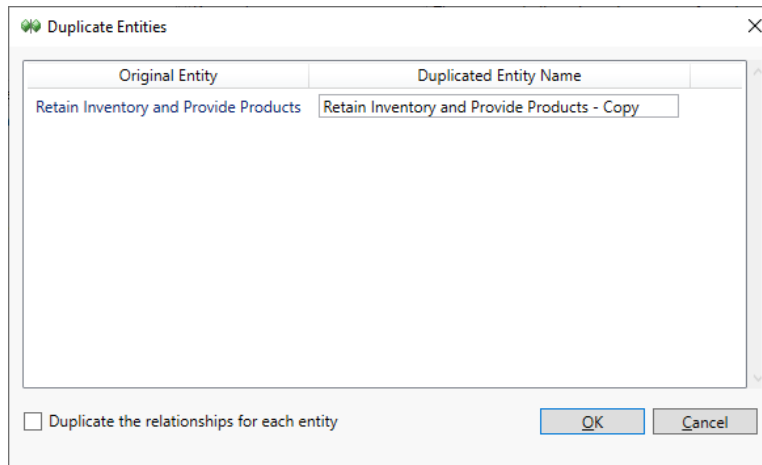

The dialog shown above offers a check box to use if you wish to copy the entity with relationships. In this case, we do not.

3. Click **Ok** without checking the box. (This will duplicate the entity without the relationships.)

The property sheet of the new entity is created. The new entity is named Retain Inventory and Provide Products - Copy. To further define the new **Requirement**:

4. Edit the **Name** field to read *Retain Inventory*.
5. Set the **Number** attribute to 4.2.1.
6. Set the **Type** attribute to *Functional*.
7. Create a *refines* relationship with 4.2 *Retain Inventory and Provide Products* as the target.

Requirement 4.2 has two statements, and at this stage, we've broken out one of them. We need to repeat the process to complete the decomposition.

8. Duplicate requirement 4.2 *Retain Inventory and Provide Products*.
9. Edit the **Name** field to read *Provide Products*.
10. Set the **Number** attribute to 4.2.2.
11. Set the **Type** attribute to *Functional*.
12. Create a *refines* relationship with 4.2 *Retain Inventory and Provide Products* as the target.

Since there are many compound requirements imported from our GL Source Document, you should examine all the requirements for compound statements and decompose them into leaf-level requirements. For the sake of brevity of this tutorial, we will skip this step, but if time permits, you are encouraged to decompose these requirements for good engineering practice.

Viewing a Traceability Spider or Hierarchy Diagram

Let's look at a Traceability view of our Source Document. If we select the GL Source document, we can show traceability from our source document down through the **Requirements**, using either the hierarchy or spider diagram. As our model progresses, the diagram can be expanded to show traceability through the entire design.

1. In the *Project Explorer* pane, select the **Document** class.
2. Select the *GL Source Document* entity to show the property sheet.

Systems Engineering Guided Tour

3. Select the **Views** tab on the ribbon.

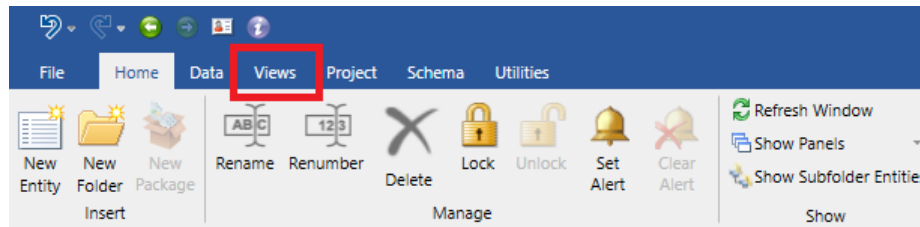

NOTE: The following steps can be done in one of two diagrams.

4. Click on either the **Spider Diagram** icon or the **Hierarchy Diagram** icon from the ribbon to open a hierarchy definition dialog.

The hierarchy definition editor provides selections for building various hierarchy diagrams. You can click the drop-down arrow to see the default set of hierarchy diagrams available. We will use **Traceability**, which was selected by default.

5. Click **OK**.

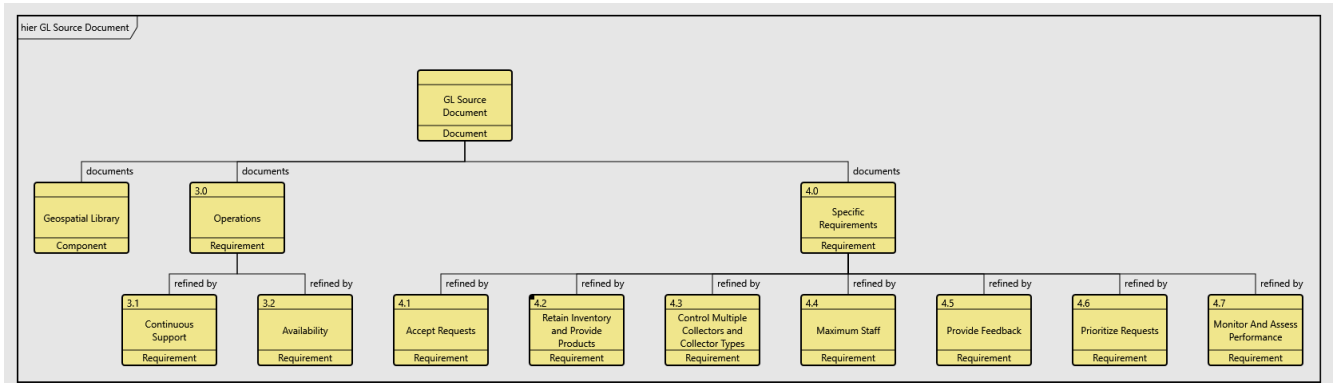

NOTE: A single icon with a black dot in the upper-left corner can be expanded individually. Select the icon, and then right-click to view a menu. Select **Expand Nodes** and set the number of levels you wish to expand below the highlighted icon; the default is one.

Adding Entities in a Traceability Spider Diagram

GENESYS allows us to create entities and relationships directly in a diagram. Using the spider diagram, we will create a relationship between the Continuous Support requirement and our System of Interest (Geospatial Library component) using the *specifies* relation.

NOTE: The following steps can be done in either the Spider diagram or the Hierarchy diagram. If you previously opened a Hierarchy diagram, close that window, then click on the **Spider Diagram** icon selecting the **Traceability** view.

1. From the spider diagram's Toolbox (found on the right side of the view,) select the **All Entities** icon, then click on the **Component** class, then the entity *Geospatial Library*. 
2. Drag *Geospatial Library* on top of *Continuous Support* on the diagram, dropping it there to display the available relations.
3. Click *specified by*.

Notice in the diagram below that new relationships have been added. These relationships will also be reflected in the underlying data model.

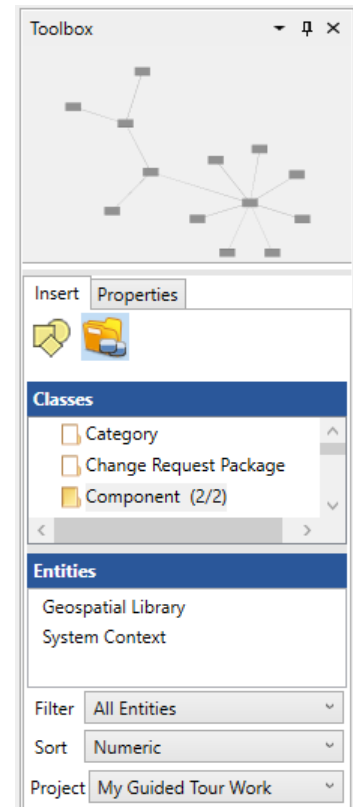

Systems Engineering Guided Tour

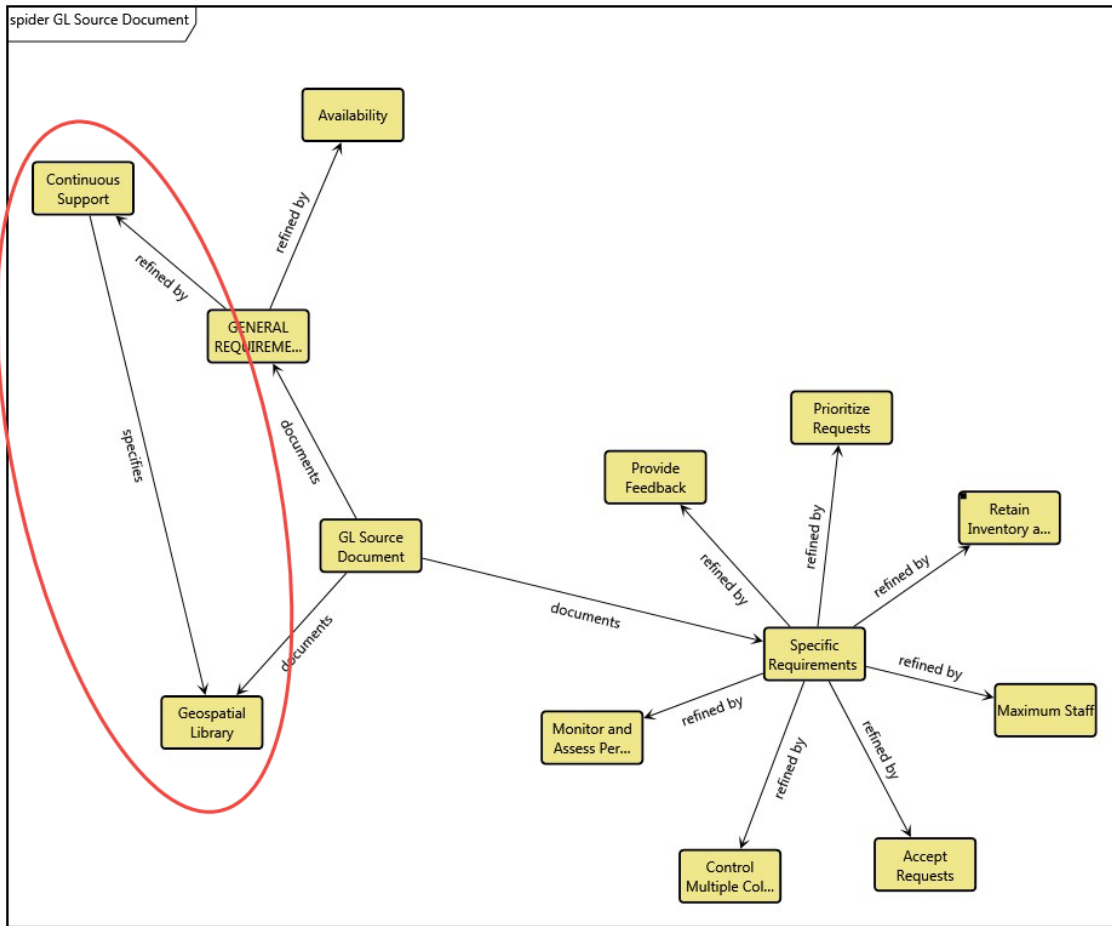

Replacing Icons with Graphics

GENESYS has a library of graphics that can be used to enhance the visualization of your diagrams. Let's change the Geospatial Library component entity to display an image in place of the traditional icon.

1. Select the *Geospatial Library* entity on the diagram.
2. In the Toolbox, click the **Properties** tab.
3. Add a checkmark next to *Show Image*.
4. Adjust the size of the image.

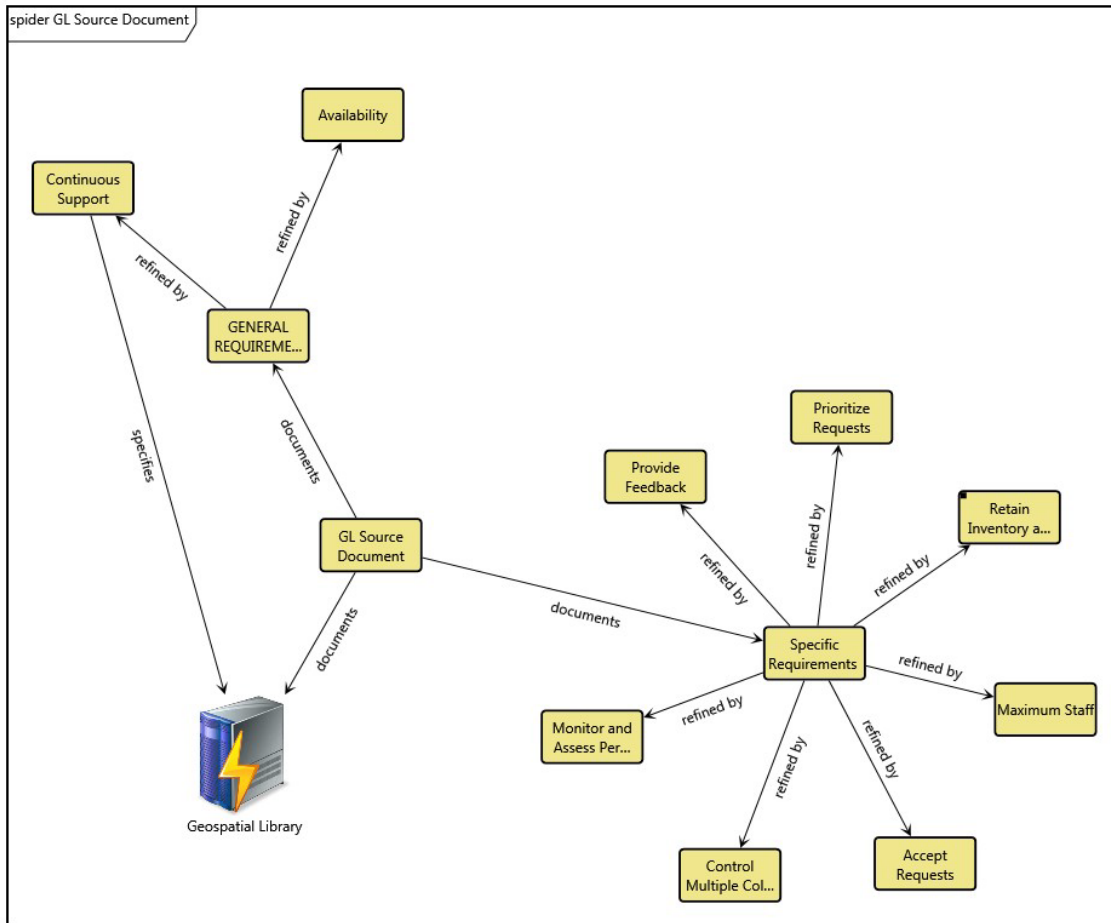

5. Close the Spider Diagram.

Capturing Requirements Concerns

Now that we have extracted the source **Requirements**, analysis begins. As a systems engineer, you want to identify problems discovered during your **Requirement** analysis to address and manage issues such as poorly written or conflicting requirements. In GENESYS, these problems can be captured as **Concerns**. A **Concern** is an entity in the design repository that identifies a problem (as well as its resolution). The primary application for the **Concern** class is documenting problems with **Requirements**, but it may be used in conjunction with any class/entity in the repository.

Systems Engineering Guided Tour

In our set of source **Requirements**, we can see that our system must accept requests from the customers. However, the format of the requests is not identified.

Let's capture that **Concern**.

Look at the *Project Explorer* pane. Did you notice that **Concern** is not listed in our list of classes?

GENESYS has defined five **Facilities** listed in the *Project Explore* pane. A **Facility** is a group of classes chosen for an area of interest. By default, GENESYS opens to the GENESYS 2024 facility when the project is first opened. This contains the foundational root classes for systems engineering and doesn't include the **Concern** class.

Let's switch to the *Systems Engineering* facility whose classes have been chosen because their entities are associated specifically with system design and specification.

1. In the *Project Explorer* pane, click the drop-down arrow next to *Essentials*.
2. Select *Systems Engineering*.

Now, let's get back to capturing our **Concern**.

3. Select the **Concern** class.
4. Double-click **Concern** to create a new entity.
5. Name the entity *Media of Request* and press **OK** to close the dialog.

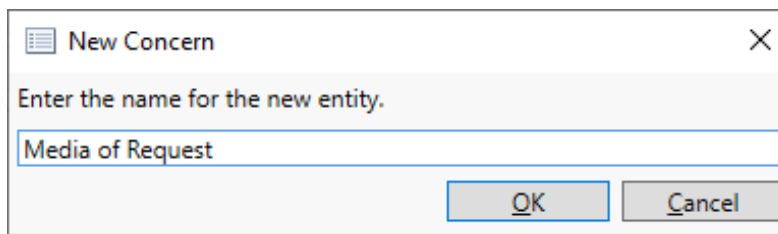

We link a **Concern** to the entity that generated the problem via the *generated by* relation.

6. Double-click *generated by* in the *Relationships* pane.
7. Add the Requirement *4.1 Accept Requests* to the Target list.
8. Click **Close**.

Systems Engineering Guided Tour

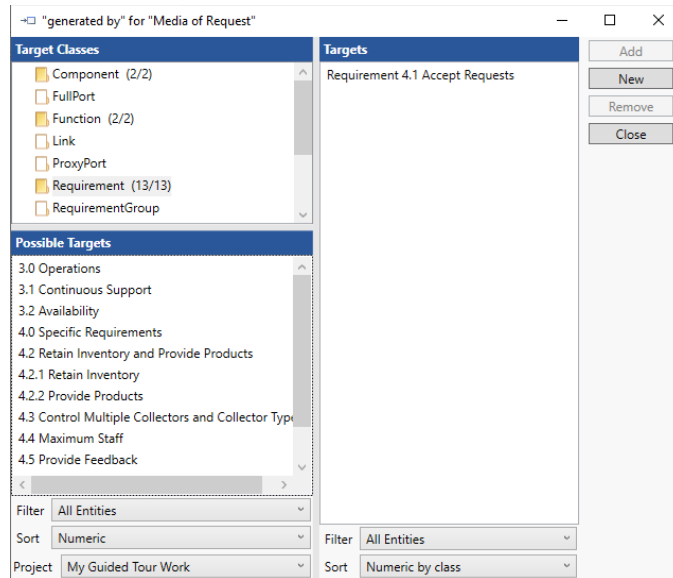

GENESYS allows you to capture both the **Concern** and the decision that resolves the **Concern**. You can document your decision, your alternatives, and your rationale in the appropriate attributes. In this way, GENESYS serves as a repository for the project design history – capturing “the why” of systems engineering decisions.

We will complete the *Media of Request* entity to capture the analysis of the problem.

9. Type text in the **Description** and **Alternatives** fields. You can use the text as shown on the image below or develop your own.

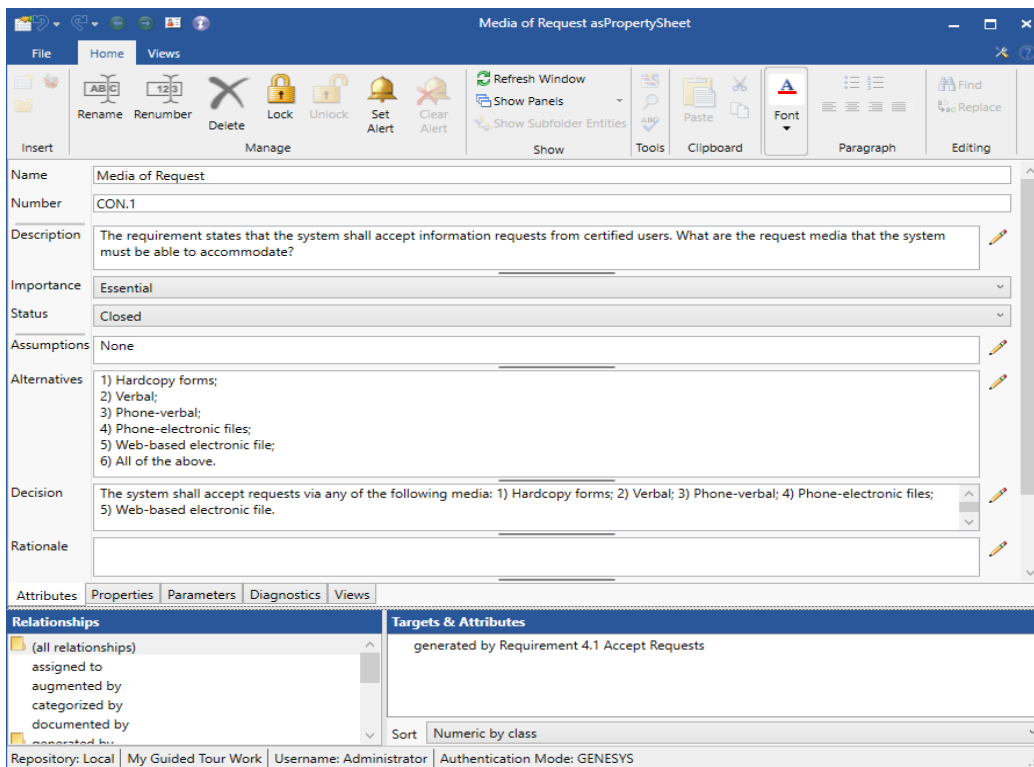

4. DEFINING THE SYSTEM AND ITS BOUNDARY AND BUILDING THE BEHAVIOR MODEL

This section will cover defining the system of interest, including the system boundary, allowing users to identify external interfaces for the system.

- Create the system
- Establish the system boundary
- View the Physical Hierarchy Define the top-level behavior
- Refine the behavior
- Utilize various diagram views
- Establish requirements traceability

Defining the System Environment

To define the system and its boundary in GENESYS, we must use the system context, identify the top-level **Components** (physical entities), their top-level (root) **Functions**, and any top-level inputs and outputs. We will determine the system boundary by defining our system of interest and the external systems in which we must interface. To begin, we need to define the overall outside of our system.

A **Component** entity of Type *System* is used to identify the system and capture the system-level mission. A **Component** is an abstract term that represents the hardware, software, people, or grouping thereof that performs a specific function(s) for the system.

The Model Assistant has created the high-level *System Context* **Component** entity, which represents the context of our system.

1. From the *Project Explorer* pane, select the **Component** class and the new entity *System Context*.

NOTE: The following steps use the BDD diagram. Similar actions can be performed in the physical block diagram.

2. Select the **BDD** tab.



3. From the Toolbox, click the **Key Entities** icon, then drag the **Component Geospatial Library** on top of *System Context* to create the *built in* relationship.

By adding the *Geospatial Library* component to the BDD, we have established that our System of Interest is a part of our System Context. We will now add the necessary external systems to the System Context, helping us identify our top-level external interfaces.

4. Click on the **Constructs** icon in the Toolbox.



5. Drag the *Parts* construct and drop it onto the *System Context* entity.

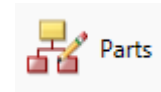

6. Select the **Component** class, then click **New**.
7. Name the new entity *Customers* and click **OK**.

This process creates the entity and establishes the *built in* relationship between the customers and our system context.

8. Repeat, adding two more **Components**: *Collectors*, and *Certification Authority*, establishing *built in* relationships to the *System Context* entity.

Systems Engineering Guided Tour

9. Click **Close** to close the relationship dialog.

Compare your diagram. NOTE: The diagram below utilizes the node template *Name*. Node templates can be set globally in Preferences on the **Application Menu** or via diagram using the **Properties** tab in the Toolbox.

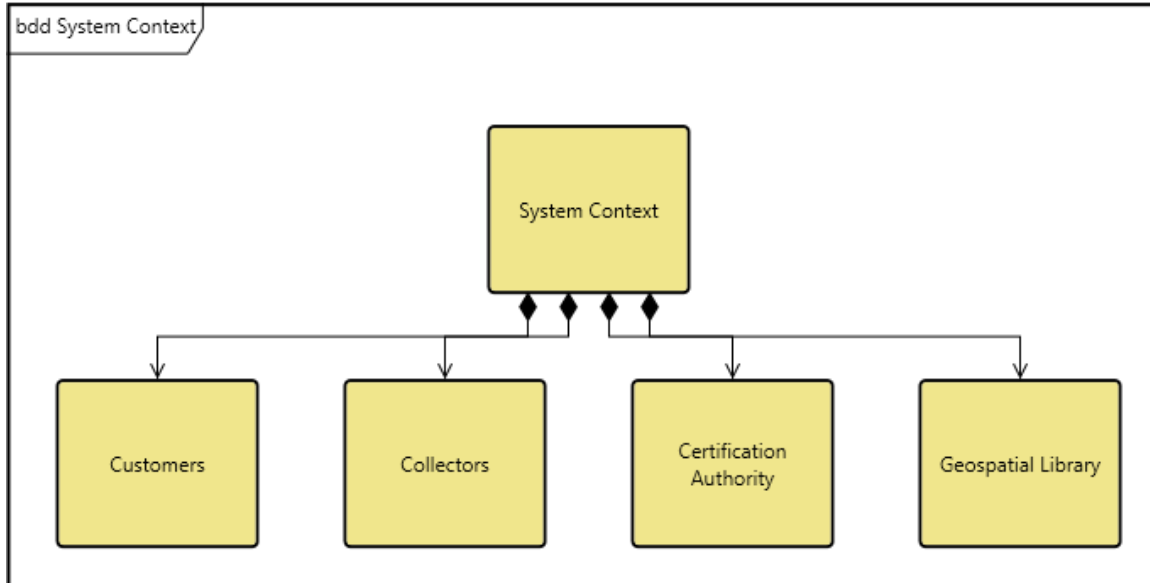

To create a well-defined model, we will now complete the definitions of the entities we just created, identifying the system of interest and the external systems contained in our system context diagram.

10. Double-click on *System Context* to open its property sheet.
11. Set the **Number** to C (identifying it as the context of our system).
12. Type the following text in the **Description** field: *The Context is the super-system that shows the physical relationship between the Geospatial Library and the external systems: Customers and Collectors.*
13. Set the **Type** to *Context*.
14. Close the property sheet.
15. Using the table below, repeat these steps to complete the entity definitions. Notice the *Geospatial Library* component will contain SYS as the prefix for the number. This is to indicate that it is the top-level component representing our system of interest.

Number	Name	Description	Type
C.1	Customers	The external system, customers, prepare requests for imagery products.	Human
C.2	Collectors	The external system, collectors, is responsible for acquiring data to support the information that is requested but does not reside in the inventory. There are multiple collectors, of different types and capabilities.	External System
C.3	Certification Authority	Provides the capability to verify a user's certification to use the Geospatial Library.	External System

Systems Engineering Guided Tour

SYS.1	Geospatial Library	This Geospatial Library demonstrates the use of automated systems engineering support tools. As defined, this demonstration system accepts requests for imagery information, determines the best way for the system to respond to the request, and then provides the requested information to the requestor. In the process of acquiring the requested information, the system may generate task orders for a set of imagery data collectors.	System
-------	--------------------	---	--------

Creating Function Entities

When the sample project was created, the Model Assistant was enabled. The Auto-create Root Function option allows GENESYS to automatically create a new **Function** entity whenever a new **Component** is created. The Model Assistant then relates the **Function** and **Component** with the *performs/allocated to* relation and sets the function's behaviorType attribute to *Integrated (Root)* to identify that this is the top-level **Function** which represents the totality of functionality performed by the system. This would later be decomposed into all the functions performed by the system. The creation of a **Function** for each **Component** and the traceability between the two is important for consistency within your model since each **Component** must perform at least one **Function** for our system. GENESYS names the new **Function** *_Perform ABC Functions*, where ABC is the name of the originating **Component**.

Let's view the existing **Functions** in our model and assign a number to each of them.

1. Select the **Function** class in the *Project* Pane.
2. Select the **_Perform Geospatial Library Functions**.
3. Set the **Number** to 0.
4. Set the remaining numbers using the following table:

Number	Name
C	_Perform System Context Functions
C.1	_Perform Customers Functions
C.2	_Perform Certification Authority Functions
C.3	_Perform Collectors Functions

We could build our functional model graphically by building either an activity diagram or an enhanced functional flow block diagram (EFFBD) of our context function, *_Perform System Context Functions*. For this example, we will use the activity diagram to show the behavior at the context level. The GENESYS activity diagrams and EFFBDs have the classic features of logic structures and functional decomposition. The logic constructs allow you to indicate the control structure and sequencing relationships of **Functions**.

NOTE: The following steps use the Activity diagram. Similar actions can be performed in the EFFBD.

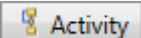
5. In the *Browser* pane, select the **Function** entity *_Perform System Context Functions*.
6. Click the **Activity Diagram** tab  to open an activity diagram of the selected entity.

NOTE: The default orientation for an Activity diagram is vertical (top to bottom). For our example, we have changed the orientation to horizontal (left to right). You can do this from the ribbon by clicking on the Layout



command and selecting Horizontal.

Systems Engineering Guided Tour

By default, dashed lines show control flow in Activity diagrams. To change to solid lines, reset the setting in the diagram *Toolbox Properties* or in *Project Preferences*.



1. Access the *Toolbox Properties*, by selecting the **Toolbox** icon on the *Diagram* ribbon and selecting the **Properties** tab in the Toolbox.
2. Uncheck the box next to *Show Control Flow with Dashed Lines*.

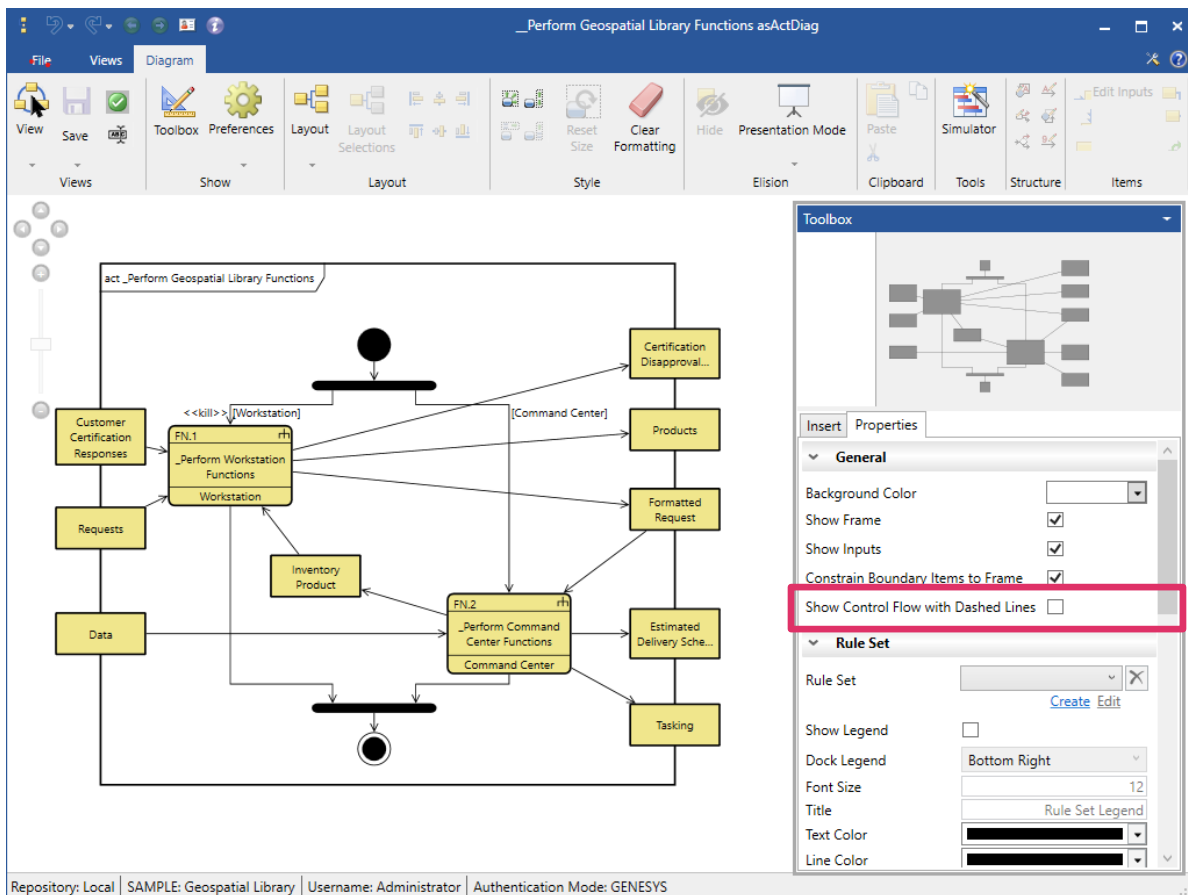

The screenshot displays the software interface for creating activity diagrams. The main window shows an activity diagram titled "act_Perform Geospatial Library Functions asActDiag". The diagram includes several nodes and connections, such as "Customer Certification Responses", "Requests", "Data", "Inventory Product", "Workstation", "Command Center", "Products", "Formatted Request", "Estimated Delivery Sche...", "Tasking", and "Certification Disapproval...". The "Toolbox Properties" panel is open on the right, showing the "General" tab. The "Show Control Flow with Dashed Lines" checkbox is unselected and highlighted with a red box. The status bar at the bottom indicates the repository is "Local", the sample is "Geospatial Library", the user is "Administrator", and the authentication mode is "GENESYS".

1. Access *Project Preferences* by selecting the **File** menu and then the **Preferences** button located on the bottom right side of the **File** menu. Then select *Preferences > Project Preferences > Diagrams > Activity*.
2. Uncheck the box next to *Show Control Flow with Dashed Lines*.

Systems Engineering Guided Tour

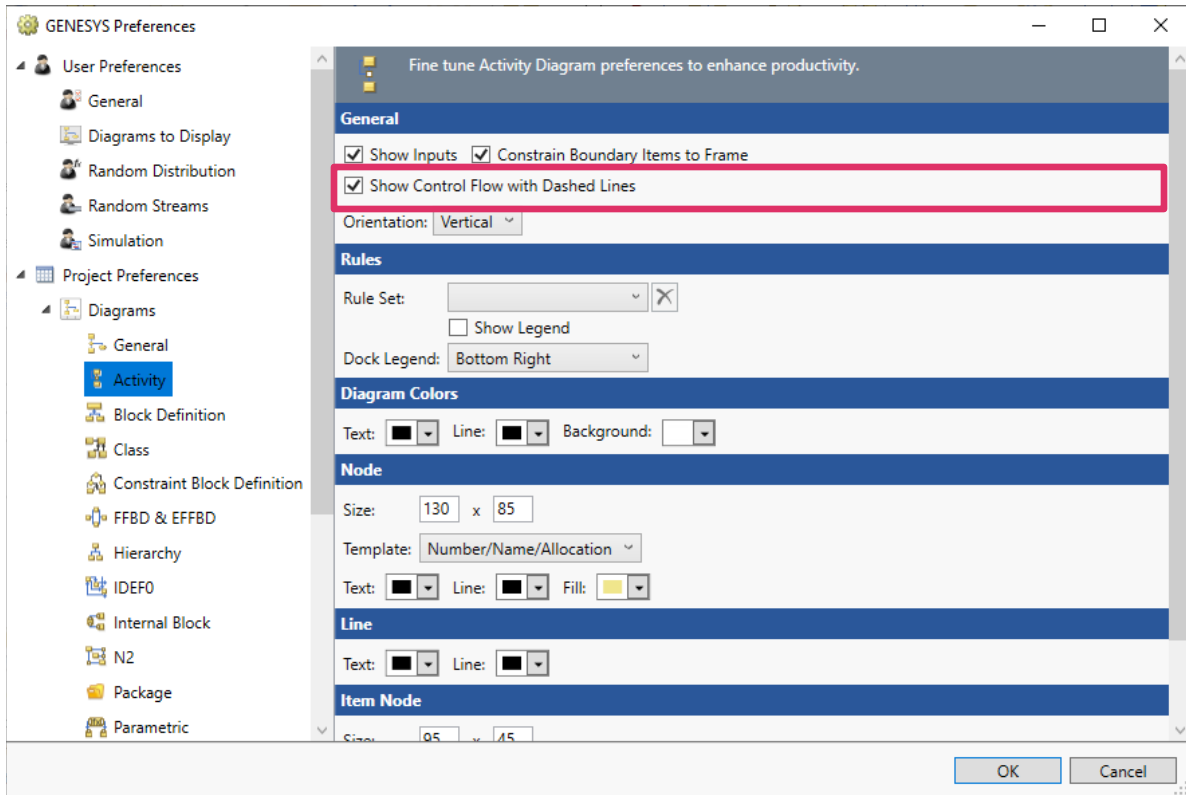

Relationships to Lower-Level Decomposed Items and Higher-Level Ancestors

Relationships to lower-level decomposed items or higher-level ancestors are represented on diagrams by connecting them to internal items on diagrams rather than to external entities. Diagrams show these relationships as connections to diagram-level descendants or ancestors.

This representation applies to all block diagram types (Physical, Interface, Internal, and Flow Internal) and the Sequence diagram.

The connections to an internal source will be represented on the diagram by a filled half circle with the same fill color as the node, at the connection point on the node, as shown below.

Systems Engineering Guided Tour

In the diagram below, the *Physical Environment* entity connects to the *Geospatial Library* entity with a filled half circle showing that the connection is to a descendant or ancestor entity.

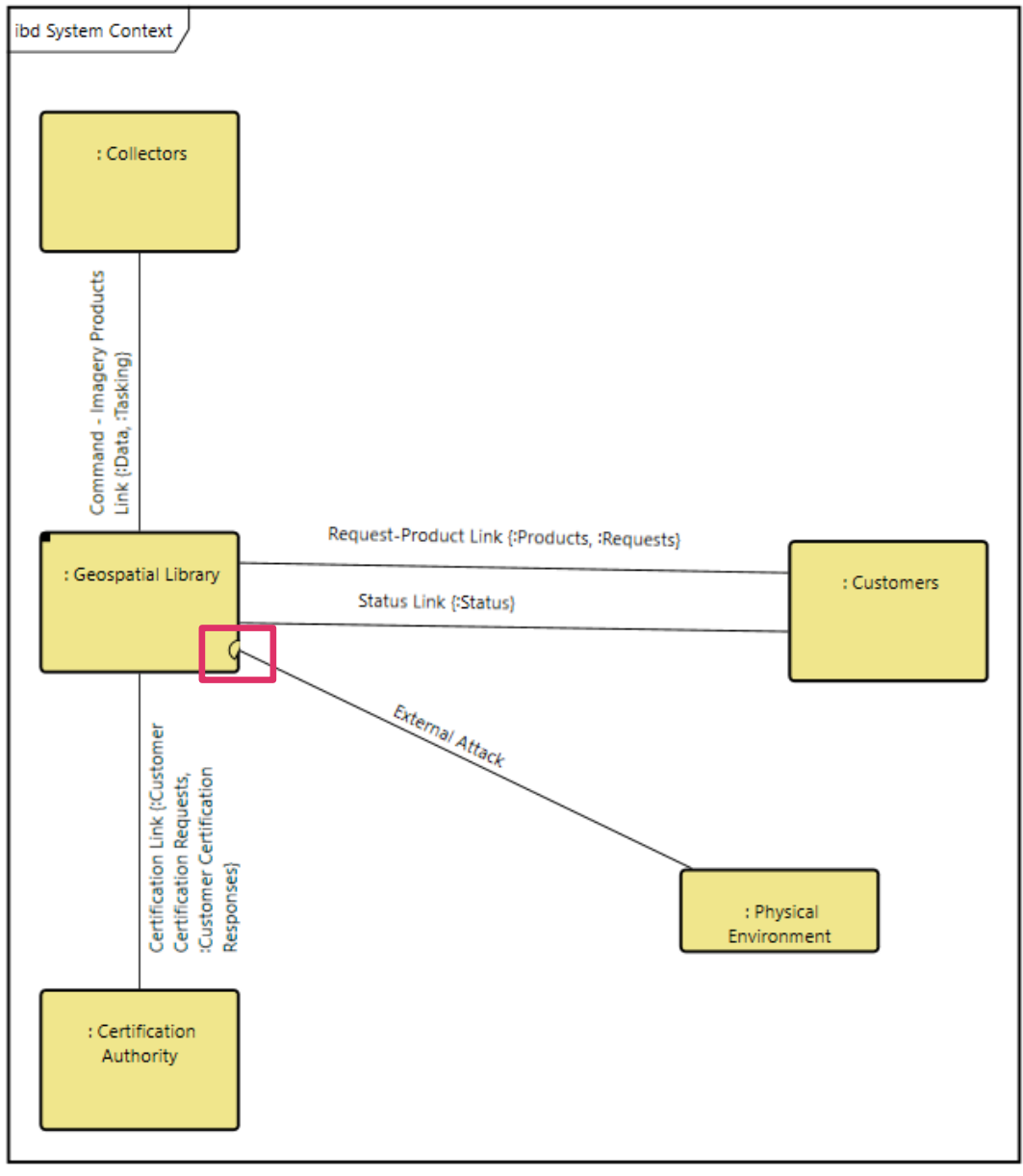

The connection point can be moved anywhere around the surface of the node.

Easily Identifying Parent-Child Relationships in Models with Up and Down Arrows

GENESYS easily identifies *Parent-Child* relationships in models with **Up** and **Down** arrows. An **Up** arrow identifies a *Child-Parent* relationship, and a **Down** arrow identifies a *Parent-Child* relationship.

When creating these relationships in the *Project Browser* pane, the *Child-Parent* and *Parent-Child* relationships have **Up** and **Down** arrows next to them, respectively.

To create a *Child-Parent* relationship:

1. Left click on the potential *Child* entity and drag-drop it onto the potential *Parent* entity.

Systems Engineering Guided Tour

2. Select “↑ built in” for the child relationship on the drop-down menu that appears, as shown below:

The screenshot displays the Systems Engineering software interface. The main window is titled "Child asPropertySheet". The interface is divided into several panes:

- Project Explorer:** Shows a tree view of the project structure, including "Database", "Packages", "Essentials", "Component", "ConstraintDefinition", "Document", "Function", "Item", "Link", "Requirement", "Risk", "State", "UseCase", and "VerificationRequirement".
- Browser:** Lists the contents of the selected package, including "C System Context", "C.1 Customers", "C.2 Collectors", "C.2.1 Satellite", "C.2.2 Unmanned Aerial Vehicle", "C.3 Certification Authority", "SYS.1 Geospatial Library", "SYS.1.1 Command Center", "SYS.1.2 Workstation", "Child", and "Parent".
- Child asPropertySheet:** The main dialog box for editing the "Child" entity. It includes fields for Name, Number, Abbreviation, Description, and Doc. PUID. Below these fields are tabs for "Attributes", "Properties", "Parameters", "Diagnostics", and "Views".
- Relationships:** A list of relationships for the "Child" entity, including "assigned to", "augmented by", "built from", "built in", "categorized by", and "causes". The "built in" relationship is selected, and a dropdown menu is open over it, showing options: "↓ built from", "↑ built in", "generalization of", and "kind of". The "↑ built in" option is highlighted with a red box.
- Targets & Attributes:** A list of targets and attributes for the "Child" entity, including "exhibits State _Exhibit Child States" and "performs Function _Perform Child Functions".

The status bar at the bottom of the window displays: "Repository: Local | Project: SAMPLE: Geospatial Library | Username: Administrator | Authentication Mode: GENESYS".

Systems Engineering Guided Tour

The new relationship appears in the *Targets & Attributes* pane on the bottom left side of the window. If the *Parent* entity is highlighted in the *Browser* pane, “*built from Component Child*” displays in the *Targets & Attributes* pane, as shown below.

The screenshot displays the Systems Engineering software interface. The top menu bar includes File, Home, Data, Views, Project, Schema, and Utilities. Below the menu is a toolbar with various icons for different modeling views and relationships. The main workspace is divided into several panes:

- Project Explorer:** Shows a tree view of the project structure, including Home, Model Assistant, and SAMPLE: Geospatial Library. The Essentials folder is expanded, showing various entity types like Component, ConstraintDefinition, Document, Function, Item, Link, Requirement, Risk, State, UseCase, and VerificationRequirement.
- Browser:** Lists the entities in the current view. The 'Parent' entity is highlighted with a red box.
- Parent asPropertySheet:** A detailed view of the selected 'Parent' entity, showing fields for Name, Number, Abbreviation, Description, and Doc. PUID. Below this are tabs for Attributes, Properties, Parameters, Diagnostics, and Views.
- Relationships:** A list of relationships associated with the selected entity. The relationship 'built from' is selected.
- Targets & Attributes:** A list of targets and attributes for the selected relationship. The target 'built from Component Child' is selected, showing its associated attributes: 'exhibits State _Exhibit Parent States' and 'performs Function _Perform Parent Functions'.

The bottom status bar displays: Repository: Local | Project: SAMPLE: Geospatial Library | Username: Administrator | Authentication Mode: GENESYS

Systems Engineering Guided Tour

If the *Child* entity is highlighted in the *Browser* pane, “*built in Component Parent*” displays in the *Targets & Attributes* pane, shown below.

The screenshot displays the GENESYS Systems Engineering software interface. The top menu bar includes File, Home, Data, Views, Project, Schema, and Utilities. Below the menu is a toolbar with various icons for different modeling activities, categorized into General, Physical, and Functional. The main workspace is divided into several panes:

- Project Explorer:** Shows a hierarchical tree of the project structure, including Home, Model Assistant, and SAMPLE: Geospatial Library. The 'Essentials' folder is expanded, showing various entity types like Component, ConstraintDefinition, Document, Function, Item, Link, Requirement, Risk, State, UseCase, and VerificationRequirement.
- Browser:** Lists the entities under the selected 'Essentials' folder. The 'Child' entity is highlighted with a red box.
- Child asPropertySheet:** Displays the properties of the selected 'Child' entity, including Name, Number, Abbreviation, Description, and Doc. PUID.
- Relationships:** Lists various relationships such as 'assigned to', 'augmented by', 'built from', 'built in', 'categorized by', and 'causes'.
- Targets & Attributes:** Shows the 'built in Component Parent' relationship, with associated targets and attributes like 'exhibits State _Exhibit Child States' and 'performs Function _Perform Child Functions'.

The bottom status bar indicates the repository is 'Local', the project is 'SAMPLE: Geospatial Library', the user is 'Administrator', and the authentication mode is 'GENESYS'.

NOTE: GENESYS enables you to create child-parent relationships with any of the classes. For instance, if you make a function a child of a parent function, it is represented by the *decomposes/decomposed by* relationship.

Systems Engineering Guided Tour

The new *Child-Parent* relationship is shown on the Hierarchy diagram, shown below.

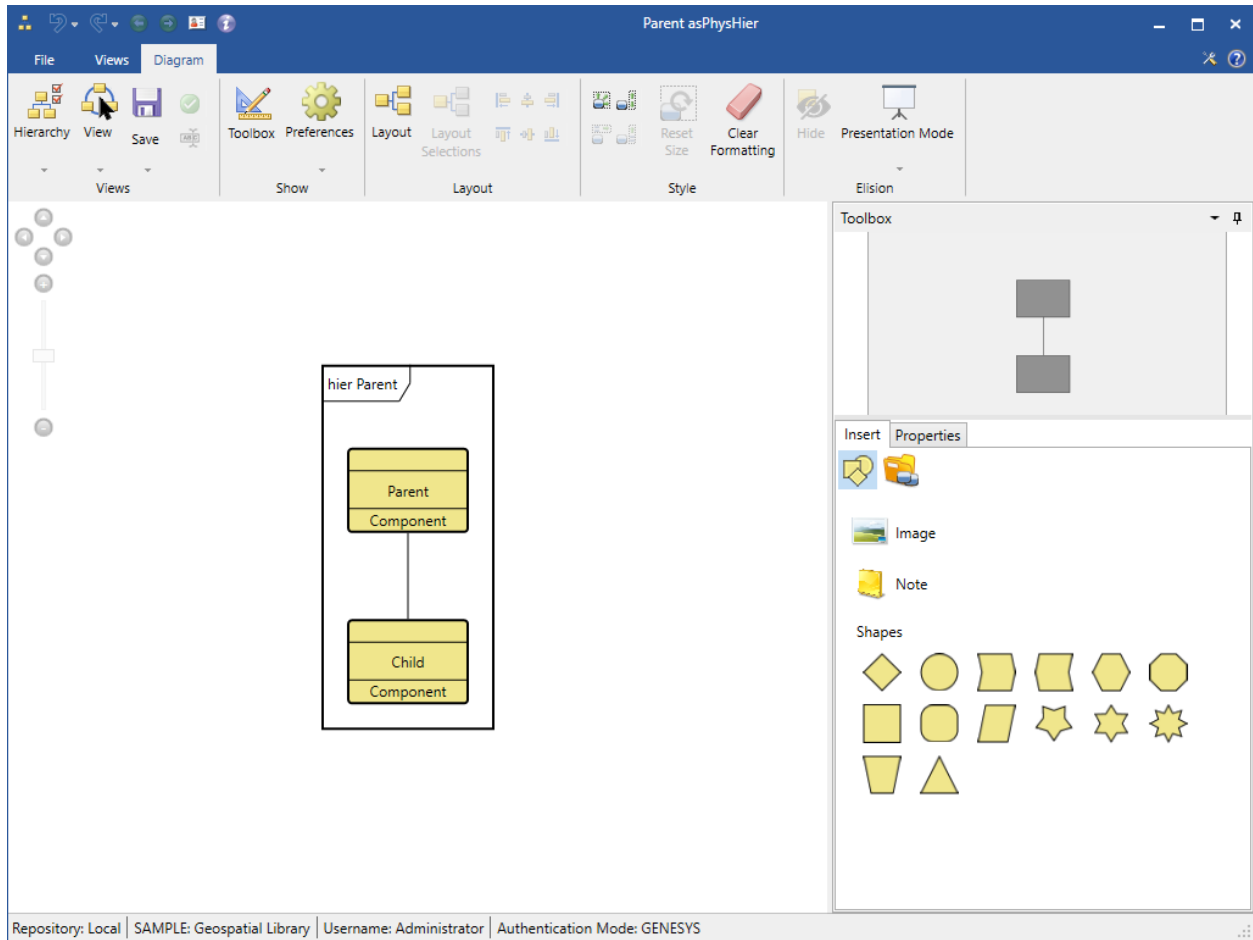

Systems Engineering Guided Tour

The BDD also shows the new relationship.

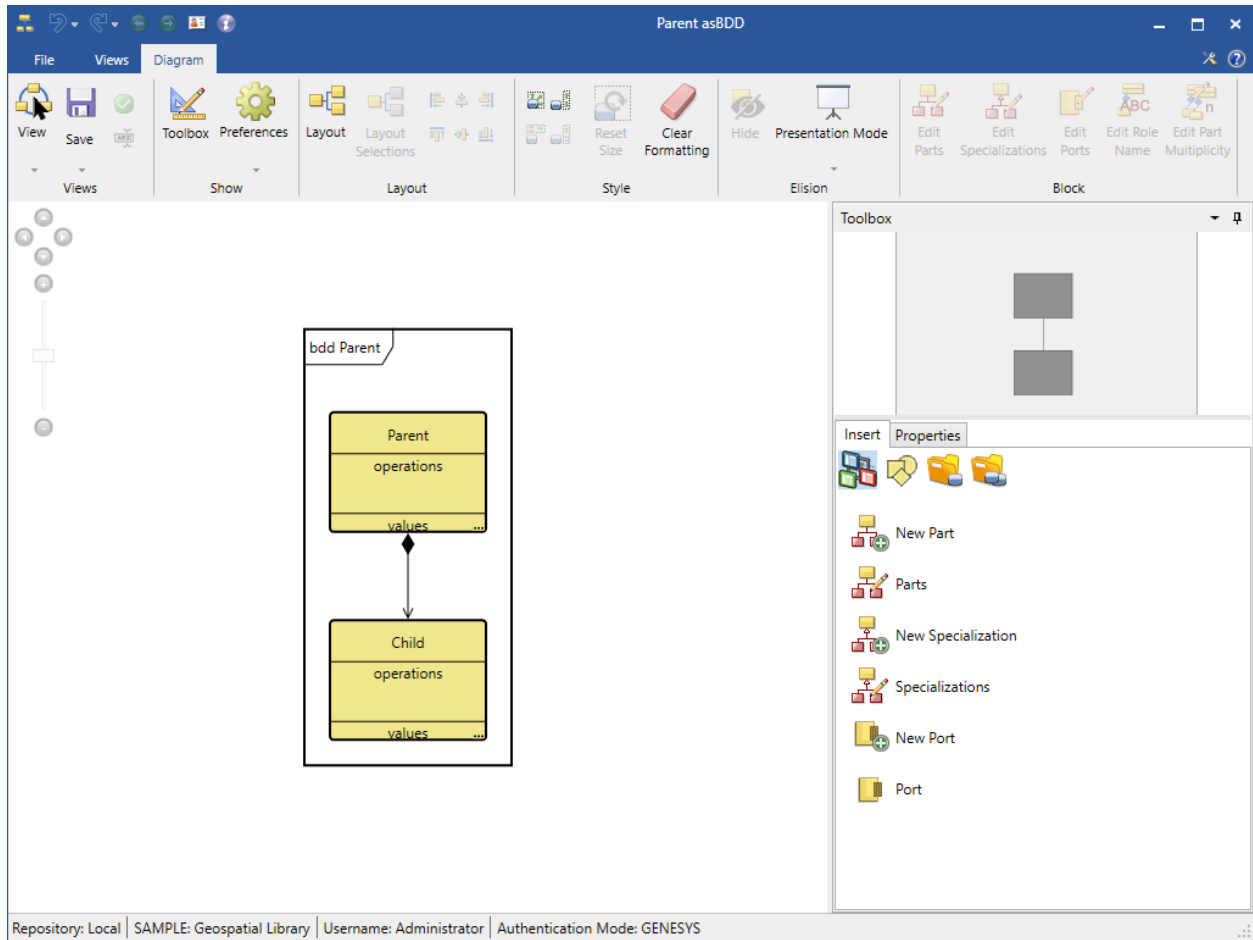

Adding Inheritance to Save Time Constructing Models

Adding inheritance to a model can save GENESYS users time constructing models. Entities can inherit attribute, property, and parameter values from other entities.

The entity that another entity inherits values from is called the *Generalization* entity and is a target of the *generalization of* relationship in GENESYS.

The entity that inherits the values is called the *Specialization* entity and is a target of the *kind of* relationship in GENESYS.

In the example below, *Collectors* is the *Generalization* entity and *Satellite* and *Unmanned Aerial Vehicle* are the *Specialization* entities that inherit from *Collectors*. The arrows with the triangle heads pointing upward indicate that the *Specialization* entities inherit from the *Generalization* entity.

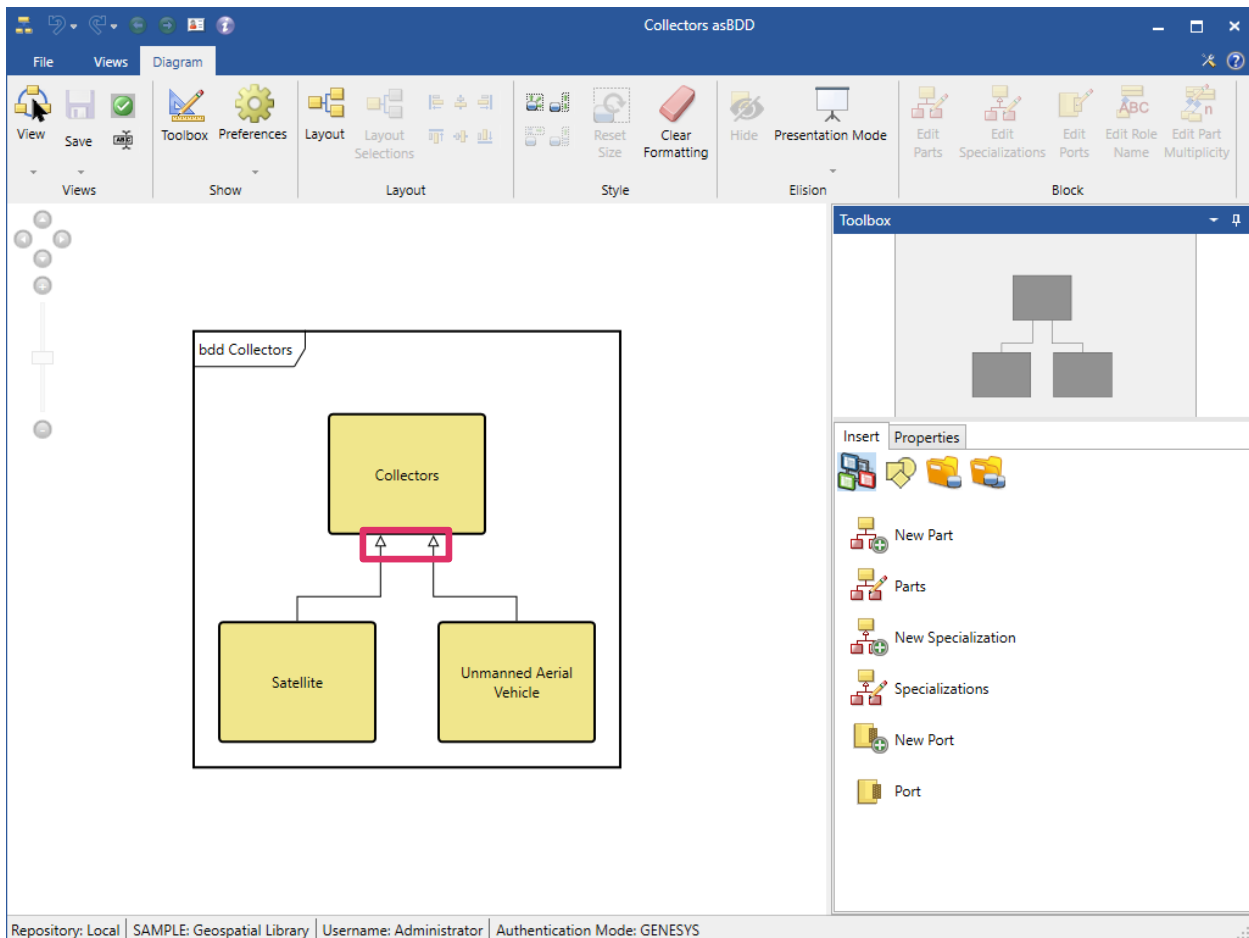



The *Specialization* entity inherits all attribute values from the *Generalization* entity by default.

The **Inheritance** icon at the right of the fields on the **Attributes**, **Properties**, and **Parameters** tabs of the *Satellite* and *Unmanned Aerial Vehicle* property sheets show which fields are inherited. The icon appears only for *Specialization* entities.

Inherited fields are read-only and can only be changed in the *Generalization* entity.

Systems Engineering Guided Tour

Turning Inheritance On/Off to Inherit or Override Values

Clicking on the **Inheritance**  icon for a field toggles the inheritance on/off for that field. A red **x** appears on the icon  indicating that the field is no longer inherited and that the value can be overridden. Users can override the value locally by entering a new value.

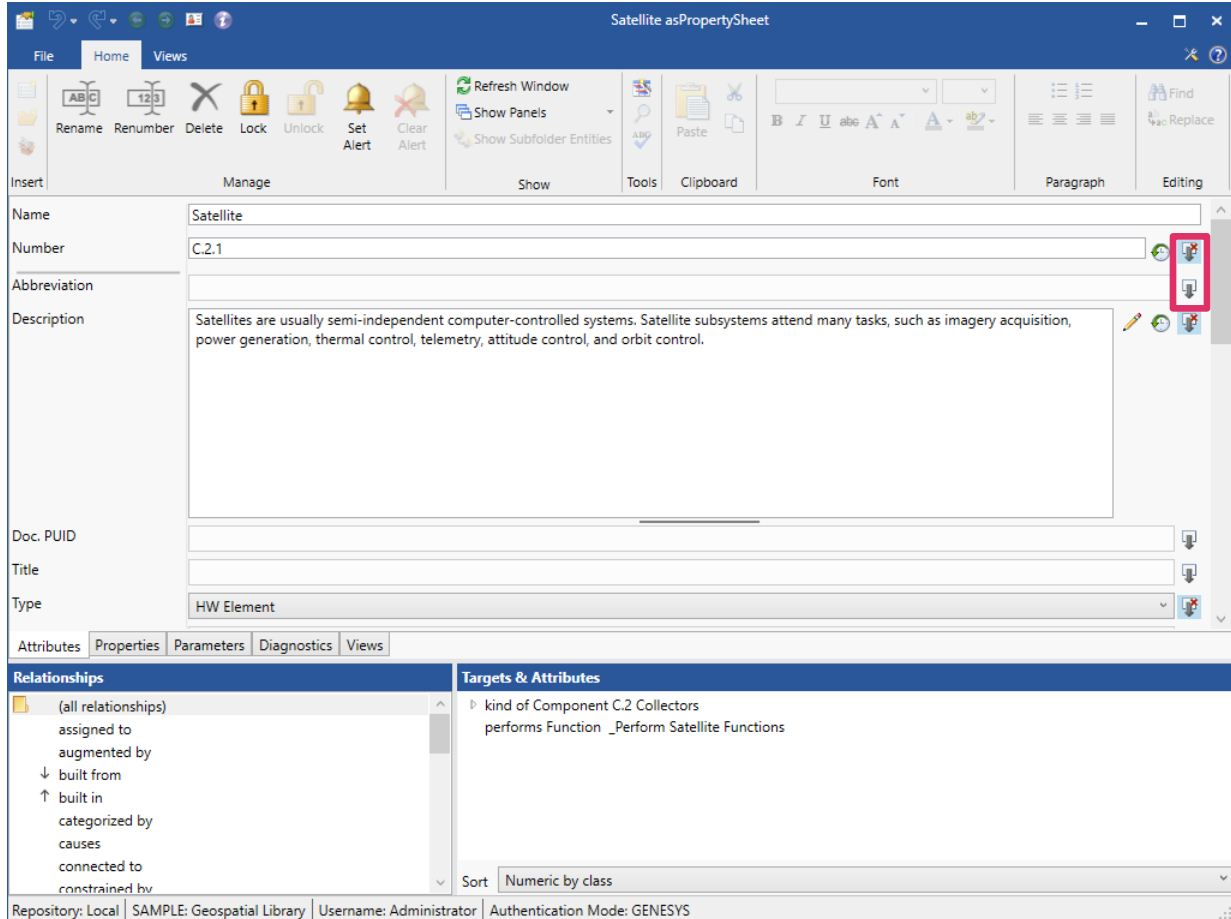

Inheriting Property Values

The *Specialization* entity also inherits text color, line color, node fill color, and image property values by default.

Systems Engineering Guided Tour

In the example below, after changing the node fill color of the *Collectors* entity to light blue, the *Satellite* and *Unmanned Aerial Vehicle* entities inherit this value and automatically display in light blue in the diagram.

The screenshot displays the Systems Engineering software interface. The main window is titled "Collectors asBDD". The interface includes a menu bar (File, Views, Diagram) and a ribbon with various toolbars: Views, Show, Layout, Style, Elision, and Block. The central workspace shows a diagram titled "bdd Collectors" with three nodes: "Collectors" at the top, "Satellite" at the bottom left, and "Unmanned Aerial Vehicle" at the bottom right. All three nodes are filled with a light blue color. To the right of the workspace is a "Toolbox" and a "Properties" panel. The "Properties" panel is currently open to the "Node Defaults" section, showing settings for Text Color, Line Color, Fill Color (set to light blue), Template, Width, and Height. Below this is the "Package Node Defaults" section with similar settings. The status bar at the bottom indicates the repository is "Local", the sample is "Geospatial Library", the user is "Administrator", and the authentication mode is "GENESYS".

Inheriting Parameter Fields

The *Specialization* entity also inherits all the parameter fields by default. Parameters that are inherited display dimmed on the **Parameters** tab like the inherited **Minimum** field in the image below.

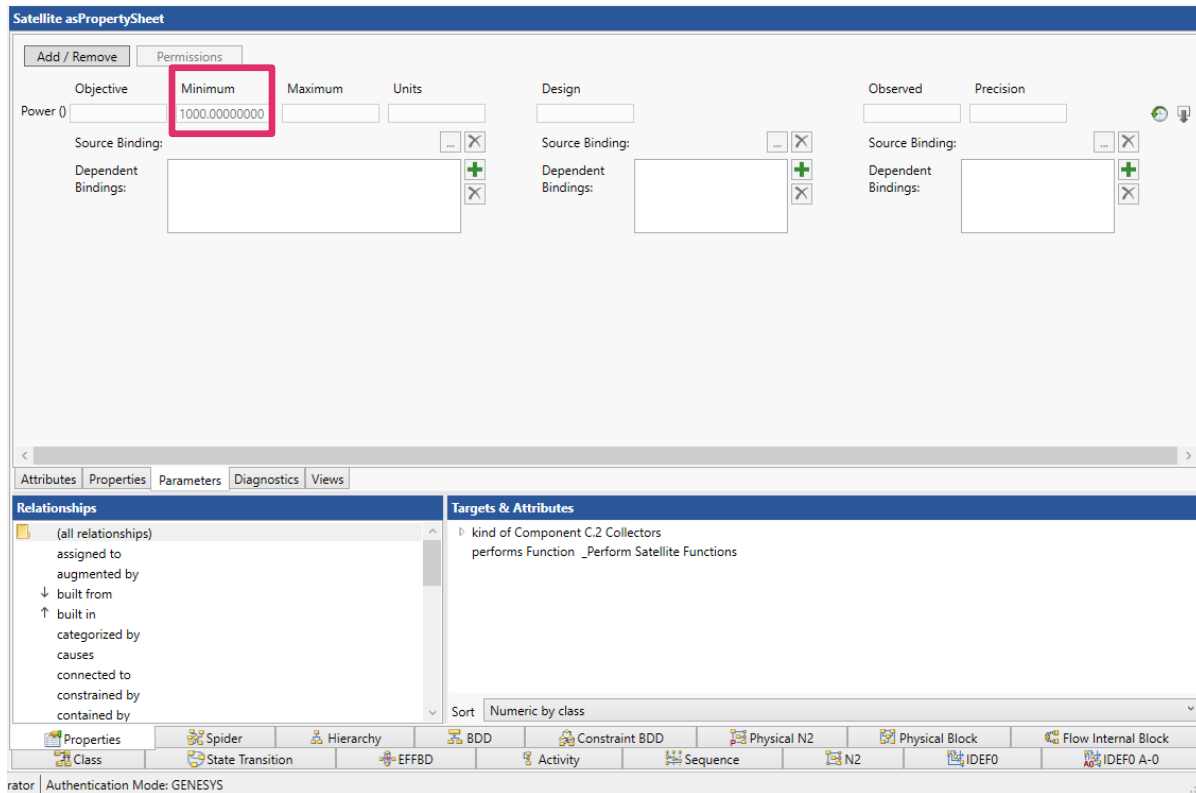

toggling the **Inheritance**  icon at the right of the field activates the field. The field becomes undimmed and the inherited value can now be overwritten.

Unlike attributes and properties, parameter fields can only be inherited/overwritten together as a group, not individually.

Inheritance can also occur across projects.

Inserting a Parallel Structure

Recall we have four **Functions** that we want to include in our System Context behavior diagram: *_Perform Geospatial Library Functions*, *_Perform Customers Functions*, *_Perform Certification Authority Functions*, and *_Perform Collectors Functions*.

Each of these **Functions** performs in parallel. To incorporate these **Functions** and to show that they will execute concurrently, we will add parallel branches to our timeline and insert each function onto its own branch.

1. From the Toolbox, click on the **Parallel** icon and drag-drop on top of the main branch.

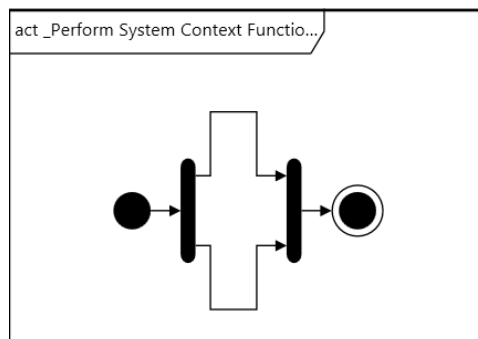
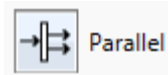

2. To add more branches, select the **Branch** icon and drag-drop it on top of either end of the Parallel construct.
3. Repeat the drag-drop of the **Branch** icon so that you have four branches as shown below.

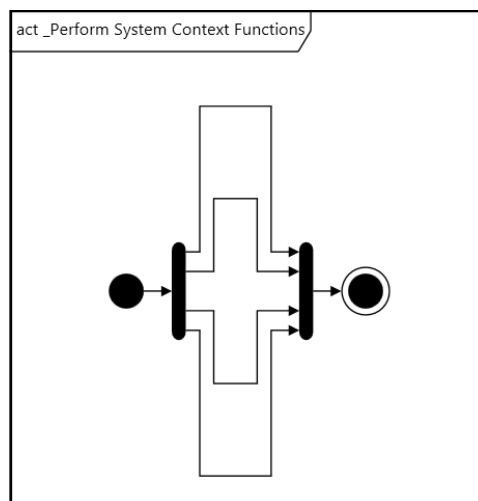
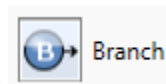

Adding Functions to an Activity Diagram

Now, using drag-drop, we'll insert one **Function** on each branch of the diagram.

The **Key Entities** tab shows the entities that can be inserted onto the activity diagram. You can select from existing entities or create new ones. In this example, we will select from context level functions, which were automatically created by the Model Assistant earlier in the exercise.



1. From the Toolbox, click the **Key Entities** icon.
2. Select the **Function** class.
3. Drag *_Perform Customers Functions* onto the top branch.
4. Repeat this step to add *_Perform Certification Authority Functions* on the second branch, *_Perform Geospatial Library Functions* on the third branch, and *_Perform Collectors Functions* on the fourth (bottom) branches and branch functions in behavior diagrams

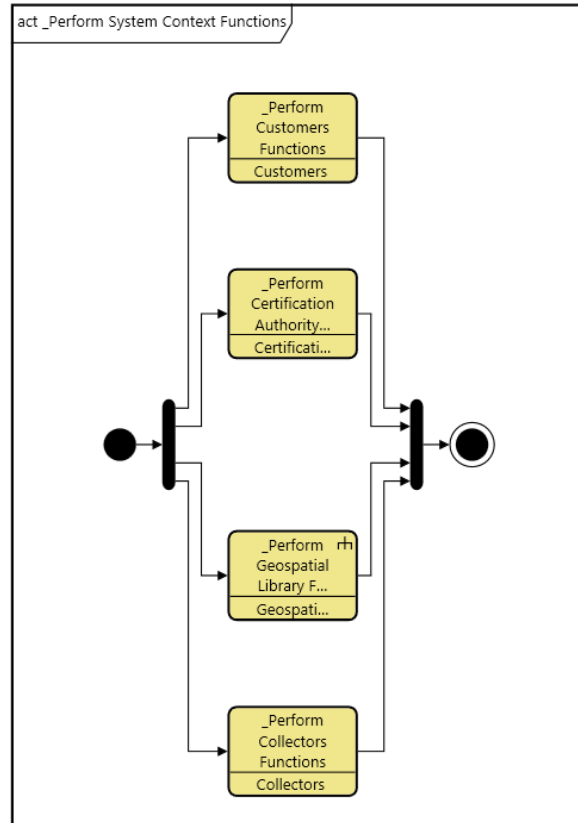

Adding Inputs and Outputs

We now need to add the inputs and outputs that occur between each of our root functions to show the interdependencies of the **Functions**. While we are performing this example using the activity diagram, the process can also be accomplished using the EFFBD and N2 diagrams.

Input and outputs are represented in GENESYS as **Items**. **Items** may be connected as either inputs or triggers. In a trigger-type connection, the receiving function will not execute until the *trigger Item* has 'arrived.' With input type connections, the **Function** will be executed independent of the **Item's** 'arrival.' In this example, each of the **Items** will be a trigger, since we would only include required interfaces and I/Os that will be exchanged between our system of interest and the required external systems on this diagram.

1. In the Activity diagram, select *_Perform Customers Functions*.
2. Hold the **Shift** key down and select *_Perform Geospatial Library Functions*.
3. Click the **Connect via Trigger** icon on the *Diagram* ribbon to open a Connection Dialog.



Systems Engineering Guided Tour

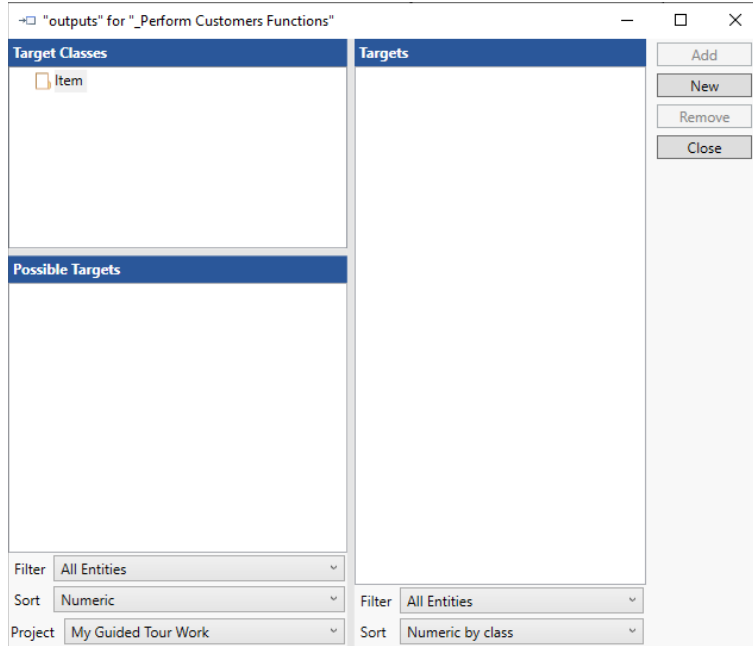

4. Double-click on the **Item** folder to create a new entity.
5. Name the new entity **Requests** and click **OK**.
6. Click **Close**.

NOTE: When using the **Shift-Click** method to select entities to connect, be intentional about the order in which you click-select them. The first entity selected will be the sending **Function**. The second entity selected will be the receiving **Function**.

To show the variety of ways you can add and represent data in the system design repository, let's switch to the N2 diagram to finish adding inputs and outputs. The N2 diagram will show the inputs/outputs between the  **Functions**, but it excludes the sequence of events between the **Functions**, since it does not include a timeline or constructs.

7. Click the **N2 Diagram** tab.
8. Using the table below as your guide, complete the model using the same **Shift-Click** method. Add the following additional **Items** as triggers: products, status, customer certification request, tasks, and data.

Item	Output from	Triggers
products	_Perform Geospatial Library Functions	_Perform Customers Functions
status	_Perform Geospatial Library Functions	_Perform Customers Functions
customer certification request	_Perform Geospatial Library Functions	_Perform Certification Authority Functions
customer certification response	_Perform Certification Authority Functions	_Perform Geospatial Library Functions

Systems Engineering Guided Tour

tasks	_Perform Geospatial Library Functions	_Perform Collectors Functions
data	_Perform Collectors Functions	_Perform Geospatial Library Functions

The resulting diagram should be similar to the following diagram:

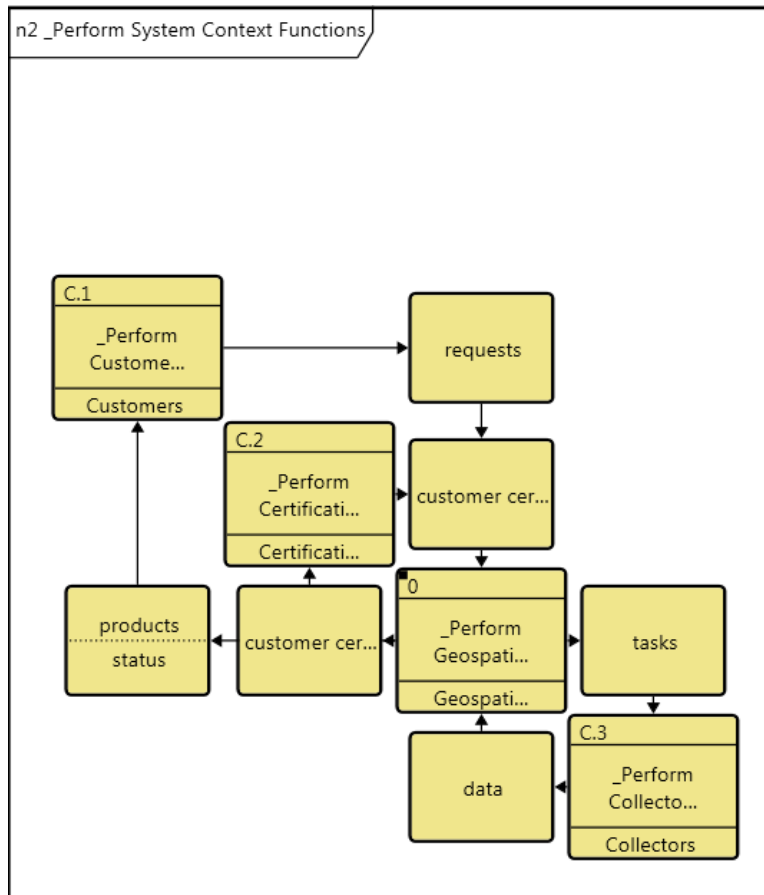

Deriving the Behavior for Our System

Now that we have defined the context of our system, we will now decompose the root **Function** for our system *_Perform Geospatial Library Functions*.

Because this tour is intended as an introduction to GENESYS we will not work through the entirety of the system. The Geospatial Library model is simply too complex to include all the details in this tour.

We'll focus instead on a very basic decomposition. If you would like to examine the full decomposition and system behavior of our sample project, you can do so by importing *Geospatial Library Sample.gnsx* found in the *GENESYS 2024\Samples\Project Samples* folder. (Importing projects was addressed earlier in Section 2 of the Guided Tour.)

This work can be completed in either the EFFBD or the activity diagram. We will work on the activity diagram.

Close the N2 diagram.

Systems Engineering Guided Tour

1. Select the *_Perform Geospatial Library Functions* entity in the *Browser* pane.
2. Click the **Views** tab in the ribbon. 
3. Click the **Activity Diagram** icon on the ribbon to open the view in a new window.

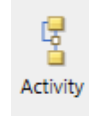

We'll use the Toolbox exclusively during this process. Keep in mind that while we are building our diagram visually, GENESYS is building an actual data model, and all diagrams are visual representations of the underlying model.

4. Drag the **New Entity** icon onto the diagram and drop it on the branch between the two end nodes.

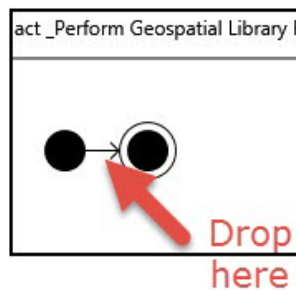

The New Entity command will prompt you for a name for the entity. Name the entity *Accept Request*.

5. Drop another New Entity construct onto the branch AFTER the *Accept Request* entity.
6. Name this second entity *Check Product Inventory*.

The outcome of the Check Product Inventory function has two paths: in inventory and not in inventory. We will capture these options using multiple exit conditions from the Check Product Inventory function.

7. From the Toolbox, drop the **Exit Condition** icon onto the Check Product Inventory **Function**. Click on the **Exit** folder and select **New** to add an **Exit** condition **in inventory** and click **New** again to add the second new **Exit** condition **not in inventory**.
8. Click **Close**.

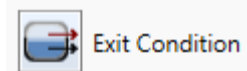

Below is the activity diagram with this multi-exit function in place.

Systems Engineering Guided Tour

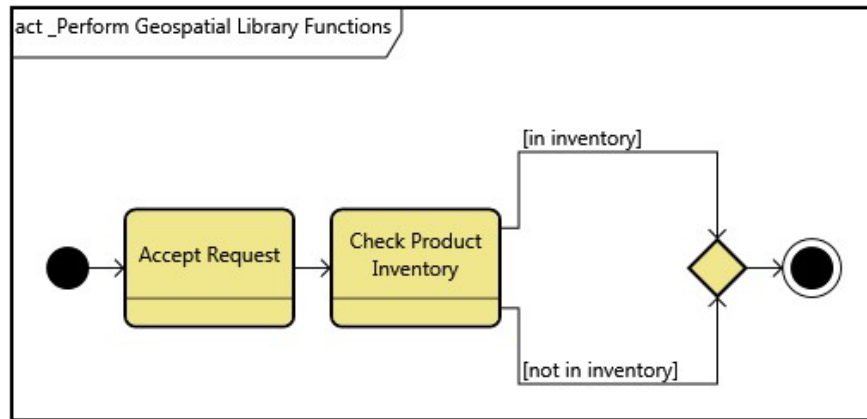

In this example, we will develop the [not in inventory] branch, to show the behavior of the system when this condition exists.

9. Drop a New Entity construct onto the [not in inventory] branch.
10. Name this entity *Prioritize Request*.
11. Add another entity AFTER *Prioritize Request* named *Determine Collector Mix*.

While our system is retrieving the image from the collectors, it will also notify the end-user of the estimated delivery schedule. We will use a Parallel construct to represent that both functions are executing concurrently. To show this:

12. Drop a Parallel construct onto the end of the [not in inventory] branch.

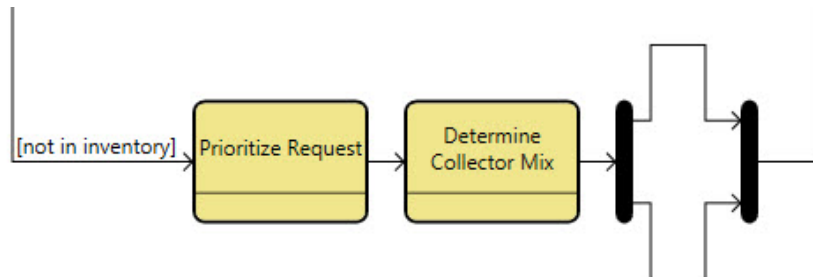

13. On the top branch of the Parallel construct drop a New Entity and name it *Notify User of Estimated Schedule*.
14. On the bottom branch, drop a New Entity and name it *Task Collectors*.
15. Now working at the end of the branch (after the Parallel construct), add two more entities in this order:
 - a. *Accept and Format Collector Products*
 - b. *Put Product In Inventory*

The ***Accept and Format Collector Products*** icon may show truncated text in the ellipse (depending on your screen size and resolution). If this happens, the following steps can be taken to size the icon so that all text is viewable.

16. Click in the background of the diagram to ensure that nothing is selected.

Systems Engineering Guided Tour



17. Click the **Auto-size** icon on the ribbon. NOTE: When **the Auto-size** icon is selected a dialog box appears: "Do you wish to resize all diagram content?" Select **Yes**.

NOTE: This command can also be used to auto-size individual nodes. Select the desired node, then click the **Auto-size** icon.

We are now finished developing the [not in inventory] branch and are ready to add two final entities to the end of the basic behavior of our system.

18. Place two more New Entity constructs at the end of the primary branch.
- *Get Product From Inventory*
 - *Provide Product to Customer*

Compare your diagram to the one below.

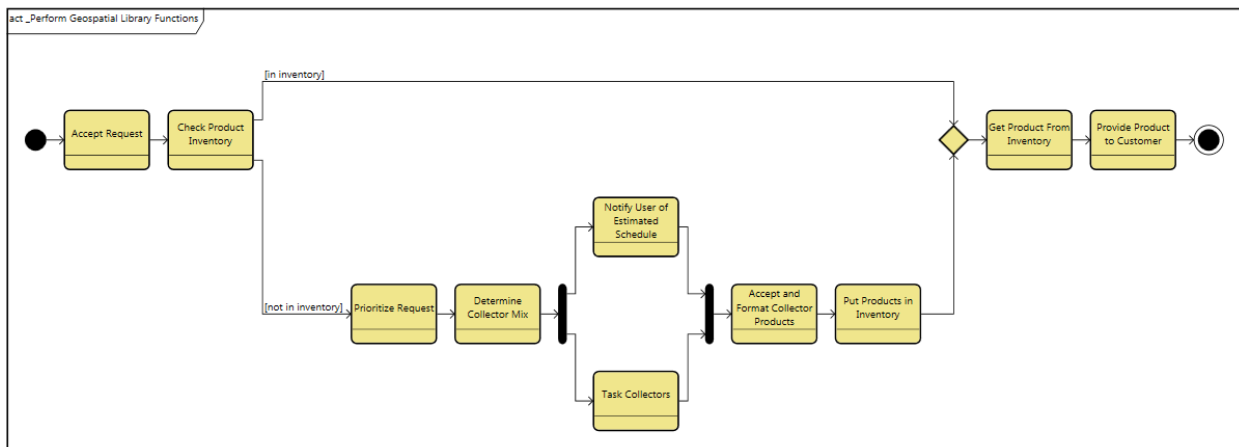

Adding Inputs and Outputs in an Activity Diagram

To complete our behavior diagram, we need to add the inputs and outputs that occur between the functions. For the following steps, we will continue to work on an activity diagram. However, you can work in another behavioral diagram if you prefer.

Just as we added triggers in the behavior diagram of our Context function, we will do the same for the Geospatial Library behavior.

Note the difference between triggers and inputs. If a **Function** has a trigger, then the trigger is required to be present before the **Function** can execute. Inputs are not required for the **Function** execution.

1. Add **Items** to the behavior model using the table below. None of these **Items** currently exist in our project, so you will need to create them as you go. Be careful to select the **Connect via Input**, **Connect via Trigger**, **Edit Inputs**, **Edit Triggers**, or **Edit Outputs** icons from the ribbon as appropriate.

Items	Actions on Functions		
		<i>output from</i>	<i>inputs to</i>

Systems Engineering Guided Tour

formatted request	Accept Request		Check Product Inventory
approved request	Prioritize Request		Determine Collector Mix
collector mix	Determine Collector Mix	Task Collectors	
estimated delivery schedule	Notify User of Estimated Schedule		
collector tasking	Task Collectors		
collector data			Accept and Format Collector Products
inventory product	Get Product From Inventory		Provide Product to Customer

After you have added your **Items** to the behavior view, take a moment to adjust the diagram for better layout and presentation.

2. Use the **Auto-size** icon to expand nodes.
3. Click and drag **Items** to reposition them if desired.

The following images show both the activity diagram and EFFBD of the Geospatial Library entity. Compare your diagram to ensure completeness.

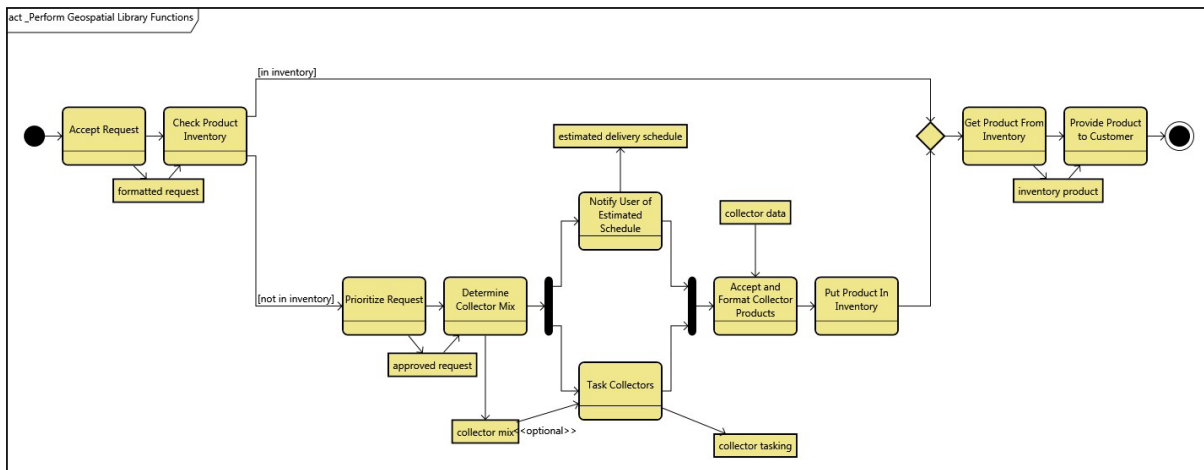

Systems Engineering Guided Tour

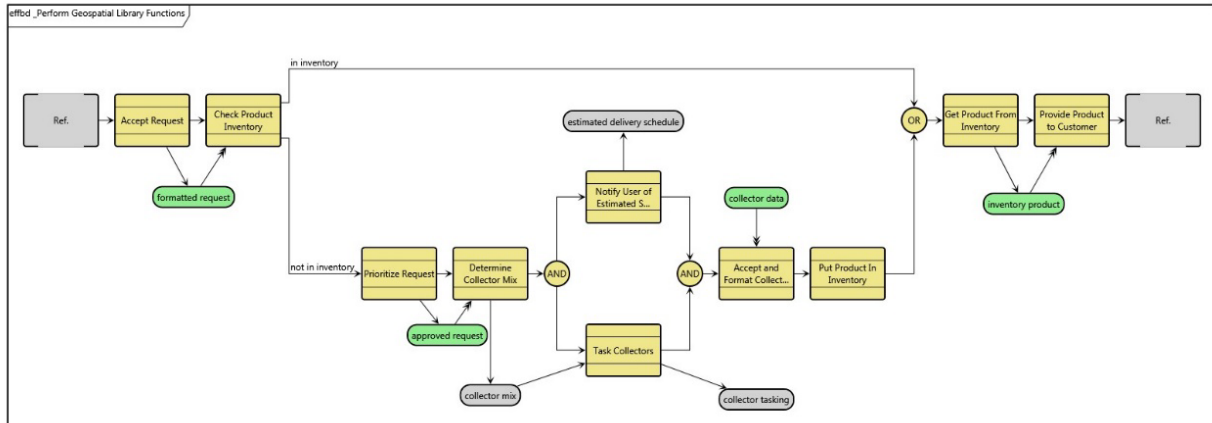

When you are satisfied, close both diagrams.

Boolean Triggering Relationship Attribute

Instead of a trigger relationship in behavioral diagrams, the *inputs/input to* relationship has a Boolean relationship attribute called *Triggering*.

Name: _Perform Workstation Functions
Number: FN.1
Description: The "root" function of the Workstation subcomponent. This function captures the behavior of the Workstation.
Doc. PUID:
Title: Perform Workstation Functions
Behavior Type: Integrated (Root)
Duration:
Attributes: Properties Parameters Diagnostics Views
Relationships: elaborates, exits by, generates, has comments, impacted by, incorporated by, **inputs**, outputs, rackared by
Targets & Attributes: **inputs Item I.1 Requests** (Triggering: True), inputs Item to Customer Certification Responses, inputs Item Inventory by
Sort: Numeric by class
Repository: Local | SAMPLE: Geospatial Library | Username: Administrator | Authentication Mode: GENESYS

To change the Boolean value, double-click the *Triggering* attribute and select *True* or *False* at the *Triggering* window that appears.

Systems Engineering Guided Tour



Adding to the Traceability

Now that we have defined our system and its behavior, let's extend the requirements traceability to identify the functional entities that fulfill each functional requirement. Note that for model completeness, each functional requirement should trace to a function defined for our system. We will use the *Browser* pane to add these traceability relationships.

1. In the *Browser* pane select the **Requirement** class and then the entity *3.1.2.2 Provide Products*. Double-click the *basis of* relation to open an Edit Targets dialog.
2. In the Edit Targets dialog, select target class **Function**. Select possible target *Provide Product to Customer*. Then click **Add**. Click **Close**.
3. Use this process to complete the remainder of the *basis of* relationships shown in the table below.

Requirement	<i>basis of</i> Function
4.1 Accept Requests	Accept Request
4.3 Control Multiple Collectors and Collector Types	Determine Collector Mix
4.6 Prioritize Requests	Prioritize Request

4. Select **Requirement 4.0 Specific Requirements** in the *Browser* pane.
5. In the **Views** ribbon select **Hierarchy** to open a hierarchy diagram. Under "Stored Definitions" in the pulldown select **Traceability** and click **OK**. A "Save Changes before Proceeding?" dialog box will open. Click **Yes**.

Compare the hierarchy diagram of the Specific Requirements entity to the one shown below. When you are satisfied, close the diagram.

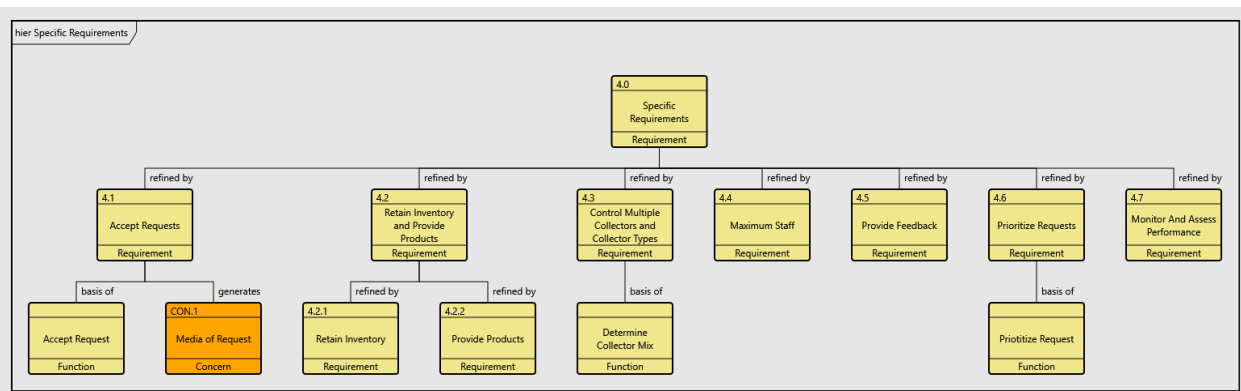

5. EDITING FREE-FORM DIAGRAMS

The *Layout* section of the *Diagram* ribbon contains commands for editing diagrams. The **Route Lines** and **Distribute Lines** commands apply to all the free-form diagrams (physical, internal, flow, interface, state transition, spider, parametric, and class block).

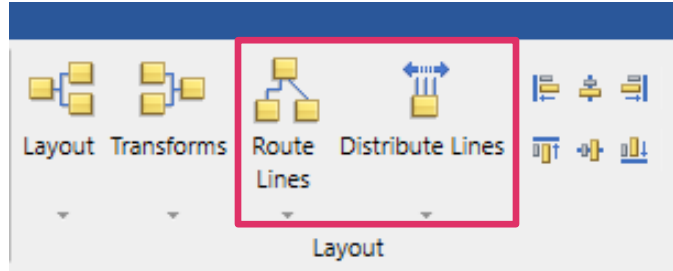

Route Lines

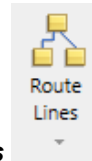

To route lines on a free-form diagram, select the **Route Lines** icon. A drop-down menu containing three route line options (routing orthogonally, polyline, or straight line) appears.

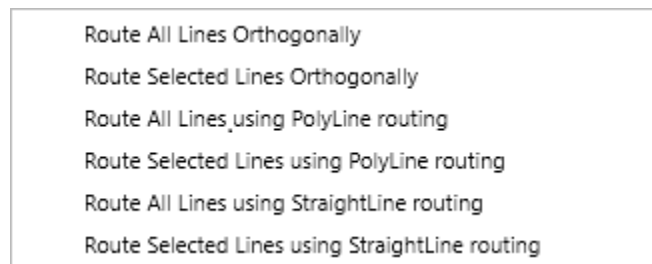

Each of the three options can be applied to all the lines in the diagram or selected lines.

Recompute Connection Points and Port Locations

When selecting the **Layout** and each of the **Route Lines** options, users can select an option to recompute the connection points and port locations, at the dialog box that displays.

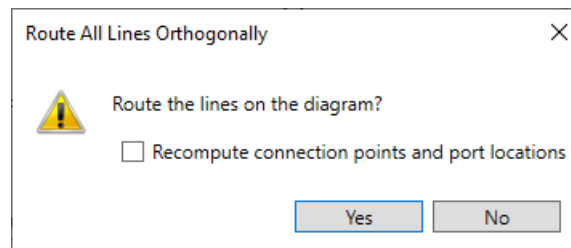

When the **Recompute connection points and port locations** option is checked, the layout algorithm will reposition the points where lines connect to nodes in the diagram to optimize the routing of the lines. Likewise, simple port nodes will also be repositioned to optimize the line routing.

Route All Lines Orthogonally with Recompute (Before)

The screenshot displays the 'Diagram' view of a systems engineering tool. The main workspace shows a diagram titled 'ibd_System Context' containing three components: ':_Workstation', ':_Command Center', and ':_External Environment'. These components are interconnected with various links, including '_Request & Product Link', '_Certification Request Link', '_GL Internal Link', '_Workstation Internal Port', '_Collector Product Link', '_Schedule Delivery Link', and 'Cmd Center Internal Port'. The connections are routed using orthogonal lines (90-degree angles). The diagram includes several ports: 'Port_001', 'Port_002', 'Port_003', and 'Port_004'. A 'Toolbox' panel is visible on the right, and a 'Properties' panel is open, showing settings for 'General' and 'Rule Set'. The 'General' section includes options for 'Background Color', 'Show Frame', 'Use Orthogonal Lines' (checked), 'Show Ports', 'Hide Port Keywords', and 'Show Item Flow'. The 'Rule Set' section includes 'Rule Set' (with 'Create' and 'Edit' buttons), 'Show Legend', 'Dock Legend' (set to 'Bottom Right'), 'Font Size' (12), 'Title' (Rule Set Legend), 'Text Color', 'Line Color', 'Fill Color', 'Node/Line Proportional' (checked), 'Node/Line Width' (120), 'Node Height' (100), 'Label Use Node Width' (checked), and 'Label Width' (120). The status bar at the bottom indicates 'Repository: Local | Geospatial - CLEAN | Username: Administrator | Authentication Mode: GENESYS'.

Systems Engineering Guided Tour

Route All Lines Orthogonally with Recompute (After)

The screenshot displays the Systems Engineering software interface, titled "_System Context asFlowIBD". The main workspace shows a diagram with three components: **:_Workstation**, **:_Command Center**, and **:_External Environment**. The connections are as follows:

- :_Workstation** to **:_External Environment**:
 - _Request & Product Link (Port_002)
 - _Certification Request Link (Port_001)
- :_Command Center** to **:_External Environment**:
 - _Collector Product Link (Port_004)
 - _Schedule Delivery Link (Port_003)
- :_Workstation** to **:_Command Center**:
 - _GL Internal Link
 - _Workstation Internal Port
 - _Cmd Center Internal Port

The diagram shows all lines routed orthogonally. A **Properties** panel on the right is open, showing the following settings:

- General**:
 - Background Color: [Dropdown]
 - Show Frame:
 - Use Orthogonal Lines:
 - Show Ports:
 - Hide Port Keywords:
 - Show Item Flow:
- Rule Set**:
 - Rule Set: [Dropdown]
 - Show Legend:
 - Dock Legend: Bottom Right
 - Font Size: 12
 - Title: Rule Set Legend
 - Text Color: [Black]
 - Line Color: [Black]
 - Fill Color: [Yellow]
 - Node/Line Proportional:

The status bar at the bottom indicates: Repository: Local | Geospatial - CLEAN | Username: Administrator | Authentication Mode: GENESYS

Systems Engineering Guided Tour

When the **Recompute connection points and port locations** option is not checked, the layout algorithm will maintain the points where lines connect to nodes in the diagram. The position of port nodes will also be maintained.

Route All Lines Orthogonally without Recompute (Before)

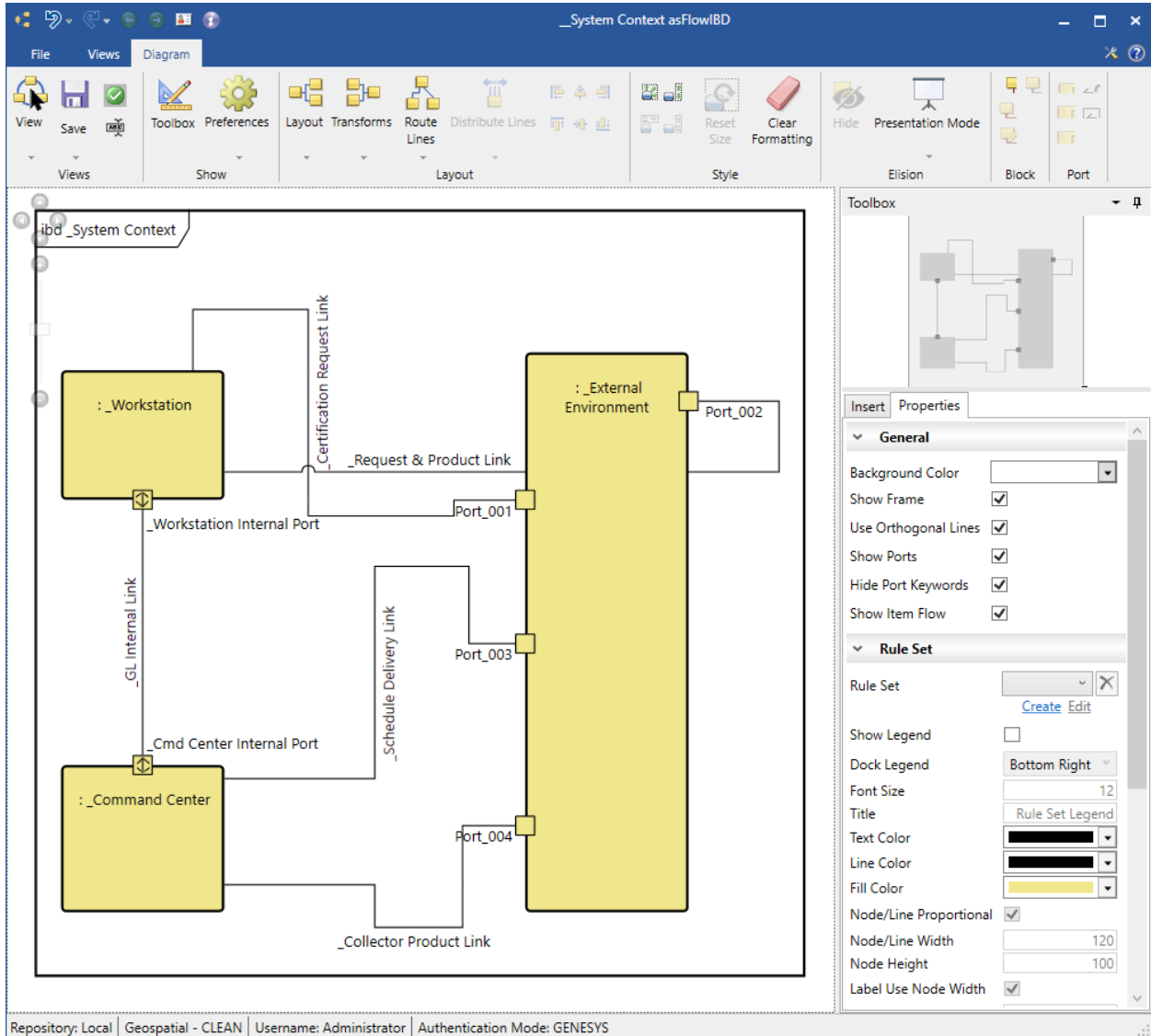

Route All Lines Orthogonally without Recompute (After)

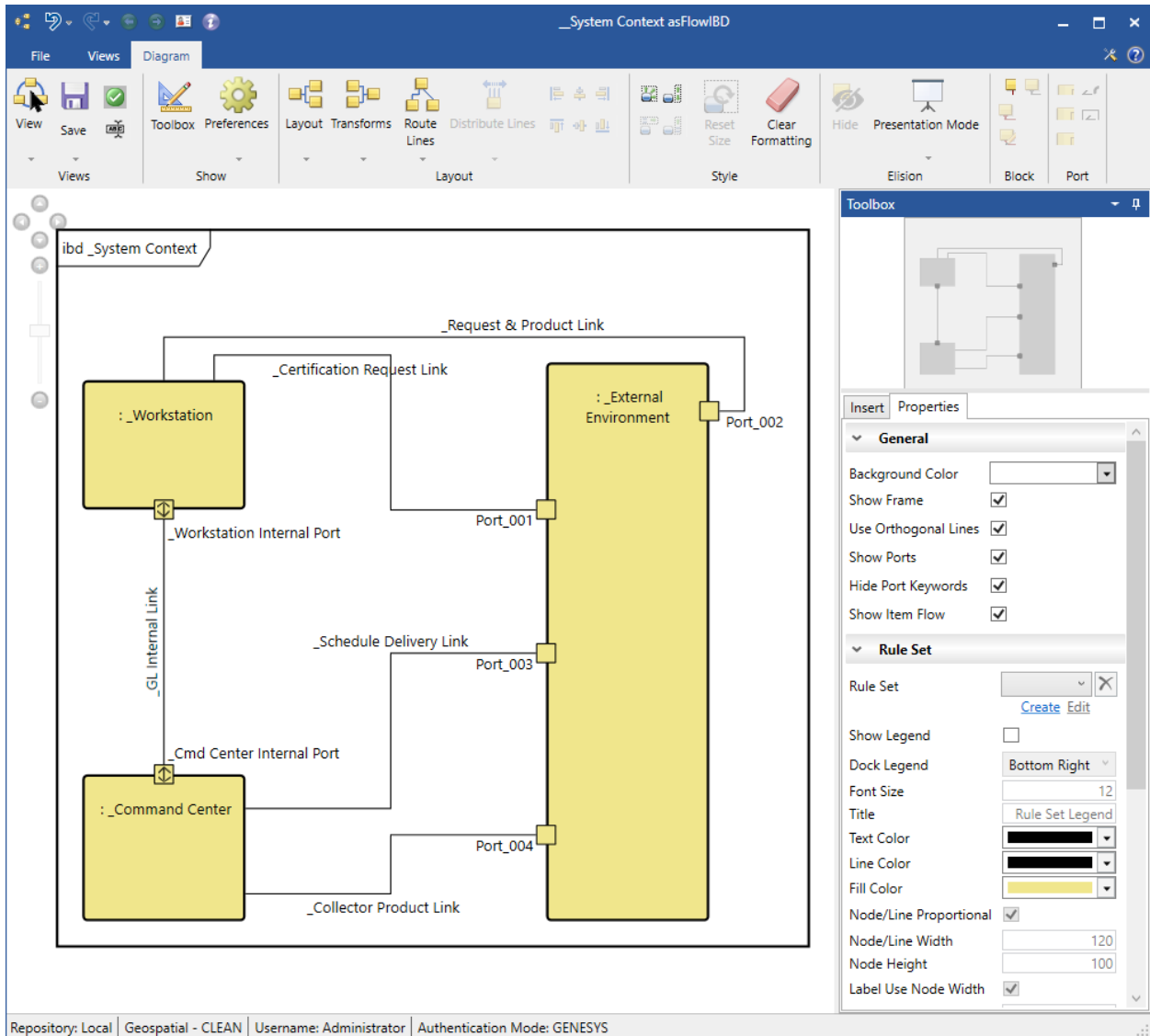

Distribute Lines

To evenly distribute all the node connections on the selected nodes, select the **Distribute Lines**

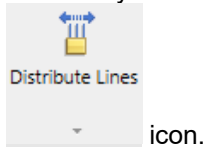

The user can also click the arrow on the bottom of the icon to access a drop-down menu that contains options for evenly distributing node connections individually on any of the four faces (sides) of the selected nodes.

Systems Engineering Guided Tour

Left Face
Right Face
Top Face
Bottom Face

This feature also distributes port nodes on the diagram. The following example shows the application of *Distribute Lines* when applied to all nodes on the diagram.

Distribute Lines (Before)

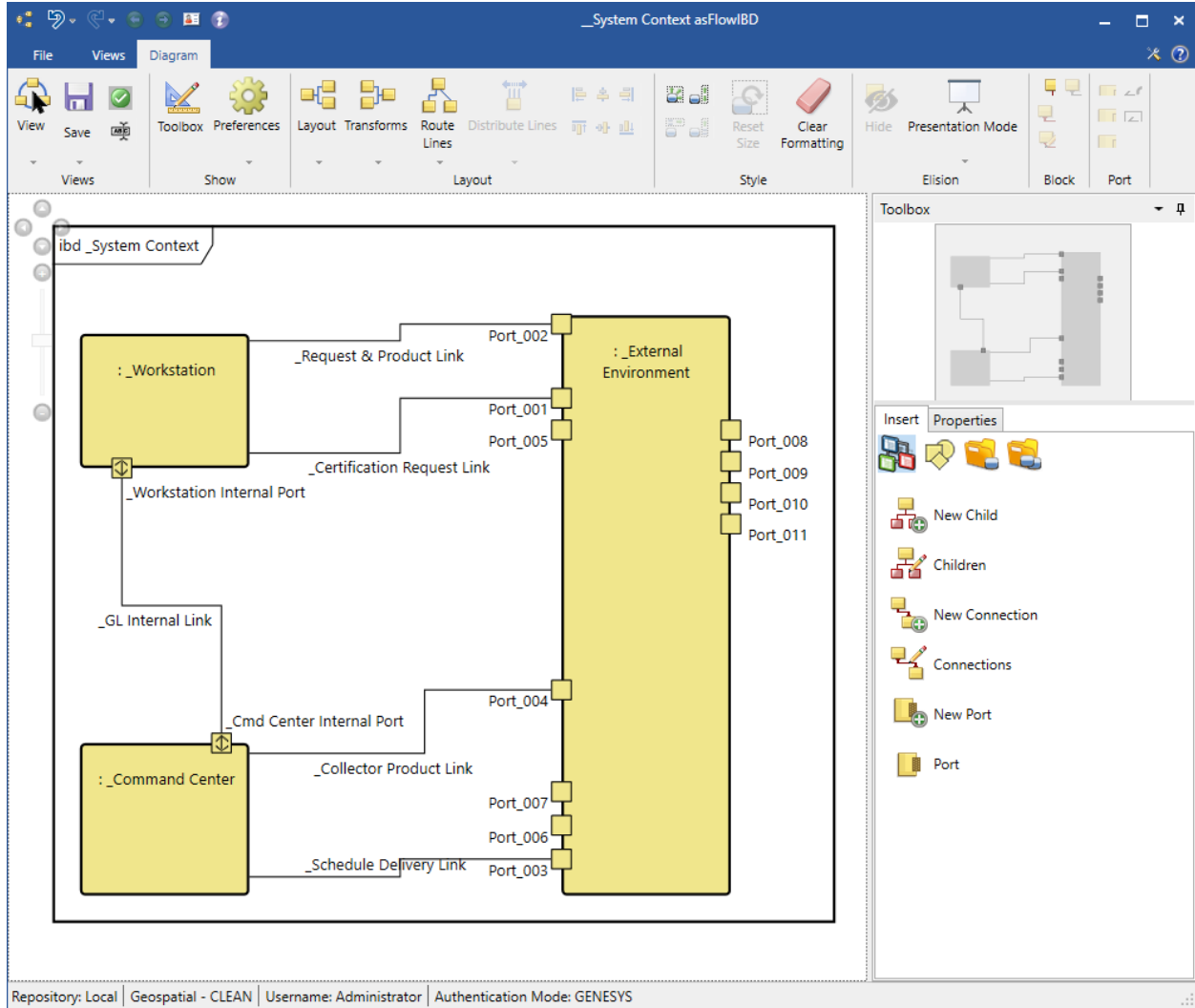

Distribute Lines (After)

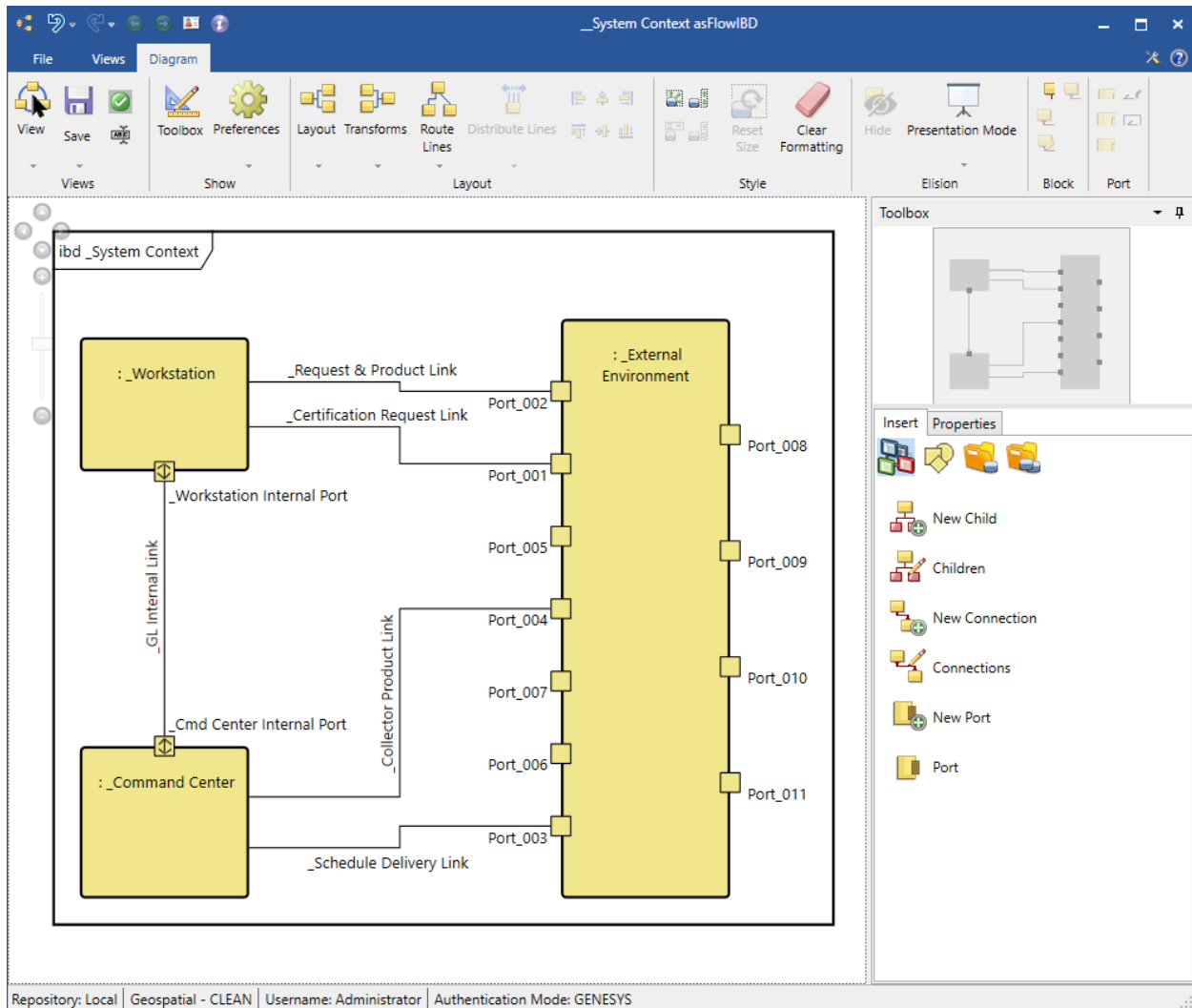

Port nodes are now considered anchored immediately after being added to a node on the diagram. They will no longer move to a new default location when new ports are added to the node. This prevents tedious rework as the layout of all connected lines was previously impacted. The new ports will be placed where there is open space on the left and right sides of the node to which the port is being added.

Lines connected to port nodes will now exit the port away from the node on which the port resides. The diagram will also attempt to maintain this behavior as the user moves port nodes and nodes containing ports. This helps prevent tedious work to achieve an aesthetically pleasing diagram.

6. COMPLETING THE PHYSICAL MODEL

This section will define the physical architecture for the Geospatial Library:

- Create components comprising the system
- Allocate functions to components
- Create physical interfaces
- Assess the model

Extending the Component (Physical) Hierarchy

Our next step is to determine how to decompose the Geospatial Library into its subsystems.

Let us now assume that our Geospatial Library is built from two subsystem **Components**: Workstation and Command Center.

1. In the *Browser* pane, create the two new **Component** entities, *Workstation* and *Command Center*.
2. Assign their **Numbers** to *SYS.1.1* and *SYS.1.2*, respectively.
3. Set their **Types** to *Subsystem*.
4. For each **Component**, establish the *built in* relationship with *SYS.1 Geospatial Library* as the target. (Note that *built in* is the inverse of the *built from* relation.)
5. Now, open a BDD of the **System Context Component**. Do this by selecting the *System Context* entity, then clicking the **BDD** view tab.

Compare your diagram to the one below.

NOTE: You can also use the Physical Block diagram.

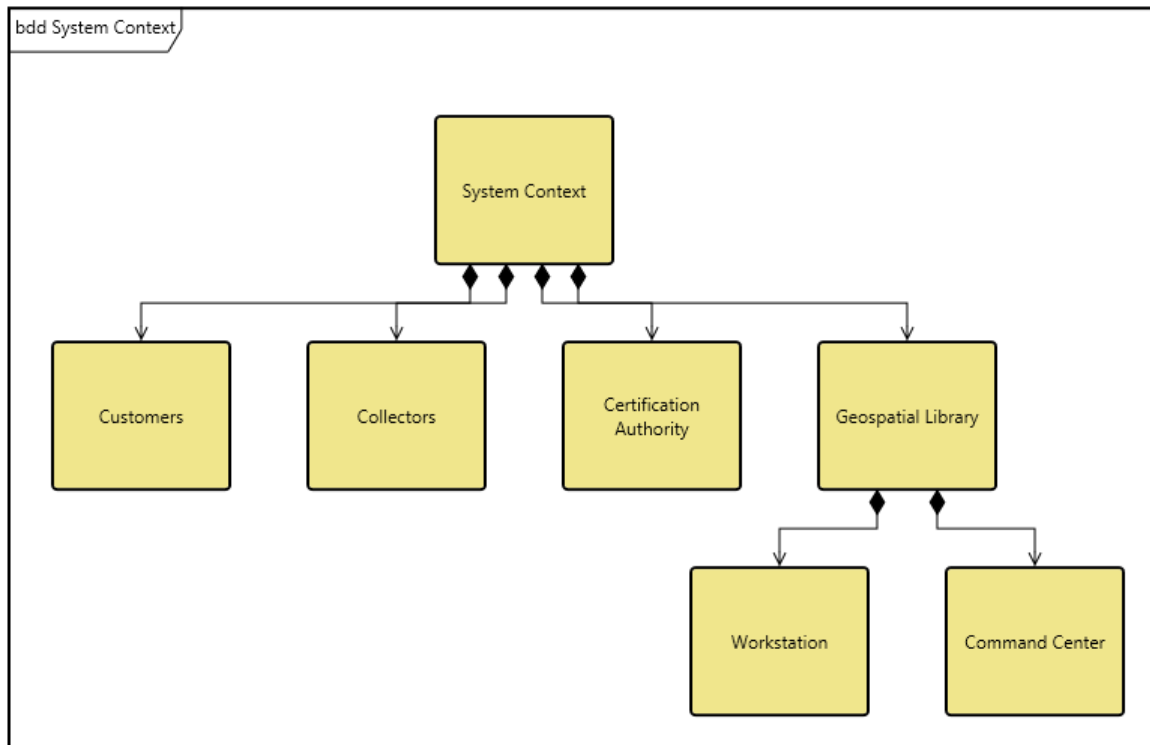

When done close the BDD.

Allocating the Functions

Now that we have completed both our behavior model and our physical hierarchy at this level, we will allocate the leaf-level **Functions** to the **Components** that will perform each function. The following EFFBDs illustrate how the Geospatial Library behavior was partitioned to the Workstation and Command Center.

Notice that the Auto-allocation on Decomposition feature of the Model Assistant has automatically created root **Functions** for our new **Components** and established *allocated to* / *performs* relationships to the **Components**.

1. In the **Function** class, select the *_Perform Workstation Functions* in the *Browser* pane.
2. On the property sheet of the entity, under Relationships, double-click the *decomposed by* relationship to open an edit targets dialog.
3. Add two **Functions**: *Accept Request* and *Provide Product to Customer*.

We have now decomposed our *_Perform Workstation Function* into two child **Functions**: *Accept Request* and *Provide Product to Customer*. Compare your EFFBD to the one shown below.

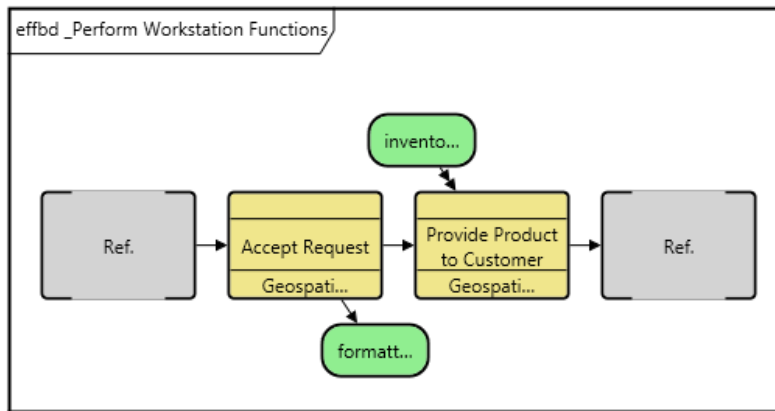

Completing the Physical Model

By allocating our leaf-level **Functions** to **Components**, we have established the behavior of our subsystems. We will now formalize our logical interfaces establishing physical connections between our **Components** at the context level.

The **Link** class is used to represent the physical connection between **Components**.

NOTE: GENESYS users can also complete the steps on this page in the Physical N2 diagram. The layout is different, but the steps are the same.

We will use the flow internal block diagram (flow IBD) to establish the physical links between the Geospatial Library and its external interfaces. The flow IBD will also allow us to show the items that are carried between the links, providing a detailed view of our architecture composition at the context level.

1. In the *Project Explorer* pane, select **Component**.
2. In the *Browser* pane, select *System Context*.
3. Open a flow internal block diagram (flow IBD) diagram.
4. Select the *Geospatial Library* entity.
5. Shift-click to select *Customers*.
6. Click the **Connect Nodes** icon on the ribbon and a connection Dialog box will pop up.

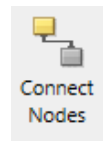
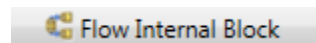

Systems Engineering Guided Tour

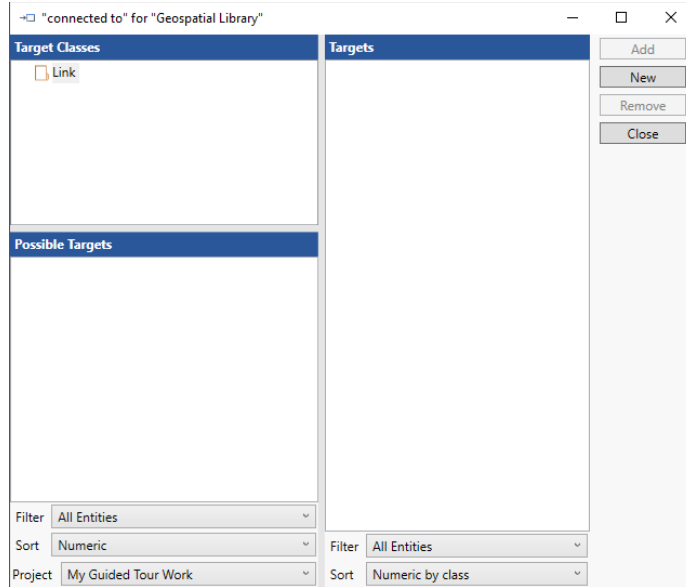

7. In the Connection Dialog, click on the **Link** folder and select **New** to create a new entity called *Request-Product Link*. Select **New** again to add another new entity called *Status Link*.
8. Click **Close**.
9. Repeat the process to add more connections as defined in the diagram below.

The default layout for the links should be adjusted.

10. Drag the nodes to arrange as displayed below.
11. Drag the connections to lay them out as displayed below. To insert a bend, click in the background so that nothing is selected, then grab the line and drag.

Now that we've established our **Links**, we need to define what each **Link** transfers between the **Components**. Earlier, we identified **Items** that are transferred when building our behavior model, and we will use those same **Items** to further define our system.

12. In the Toolbox, click the **Key Entities** icon.
13. Select the **Item** class to display the list of items.

We can now drag-drop the needed **Items** onto the **Links** to establish that the **Links** transfer those **Items**. Each time you drag-drop an **Item** onto a **Link**, the relational dialog *transferred by* will confirm the relationship you are making.

14. Use the diagram below as a reference to make additional relationships between **Links** and **Items**.
15. The text on the line will be truncated. Select the text, then drag the handle to resize.

Systems Engineering Guided Tour

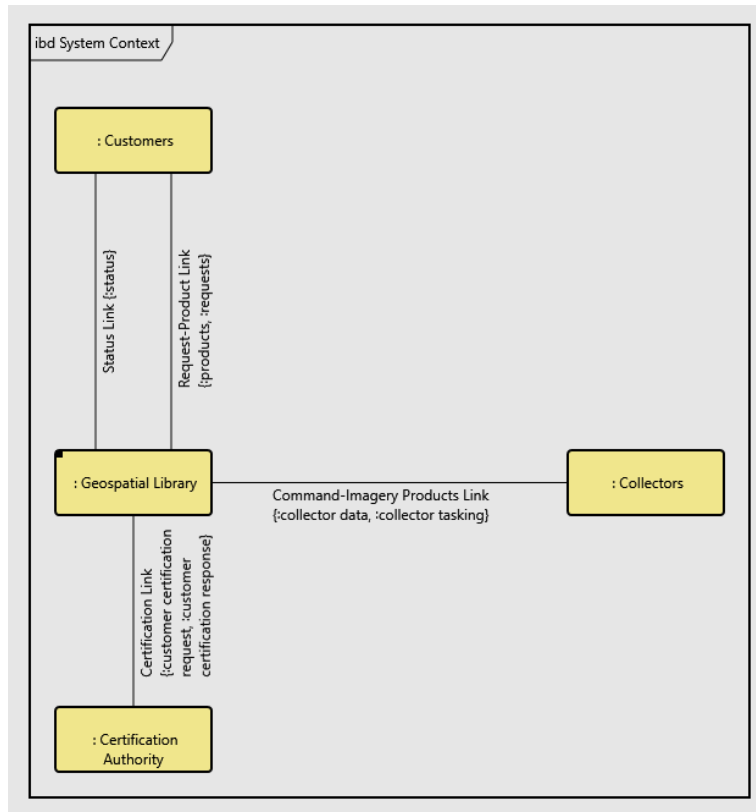

Impact Analysis

To show the power of developing our system model with diagrams and seamlessly updating the integrated system design repository, we will walk through a typical systems engineering impact analysis using system diagrams.

Suppose that the customer wants to know the impact of exchanging/replacing the Collectors. We can use the hierarchy diagram to show how a physical change to the system context can impact the system behavior. To do this:

1. Select the **Collectors Component**.
2. Click either the **Spider** icon or **Hierarchy** icon from the **Views** tab on the ribbon.
3. Select **Behavior Impact of Physical Change** from the list of stored definitions and click **OK**.

A diagram like the one below will open. This diagram allows us to visually identify all the **Functions** and **Items** associated with the selected **Component**, and now we can assess the impact of the system functionality due to a change to the external system.

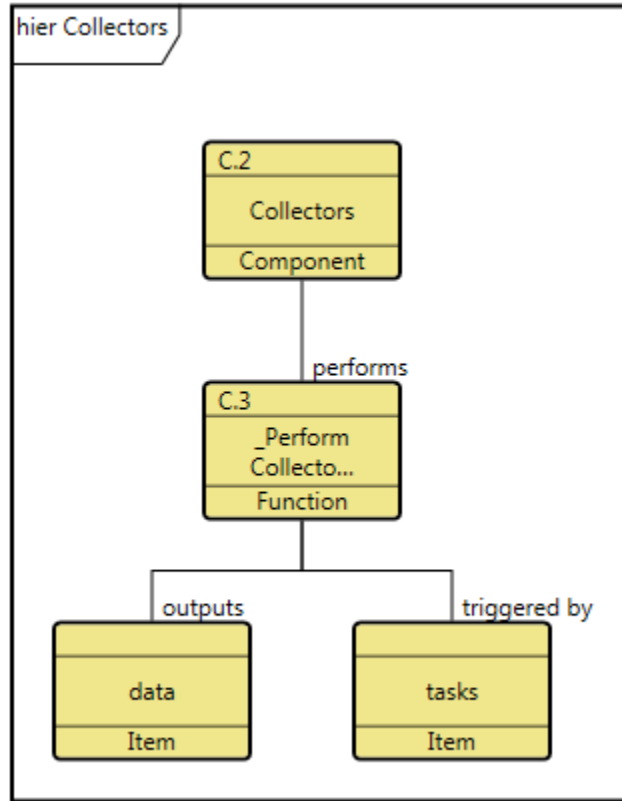

Ensuring Full Traceability from Source Document to Physical Architecture

Complete traceability within our model indicates which parts of a system design satisfy specific source **Requirements** and allows easy impact assessment of changes to system **Requirements**. Reverse traceability provides the ability to determine specific **Components** that have been defined without benefit of system analysis. Data traceability also allows for model consistency, which is difficult to attain when tracing entities from document to document without the benefit of an integrated design repository. This means that all incompatibilities are checked and resolved, the design is complete (all interfaces and environments are specified), and the design is feasible (all critical entities are demonstrated).

Using relationships for traceability makes it easy to detect unfulfilled **Requirements** and unresolved **Concerns**.

- 1 Close the Hierarchy Diagram window.
- 2 Select the **Requirement** class in the *Project Explorer* pane.
- 3 At the bottom of the *Browser* pane, select *Unaddressed Requirements* from the filter drop-down list.

This will filter the entity list to display only those **Requirements** that do not have targets for the *basis of*, *refined by*, and *specifies* relations.

For example, we see that Requirement 4.4 *Maximum Staff* has not yet been addressed. A traceability hierarchy diagram does not have to be opened to determine that 4.4 has not yet been addressed.

Systems Engineering Guided Tour

4 Reset the filter to **All Entities**.

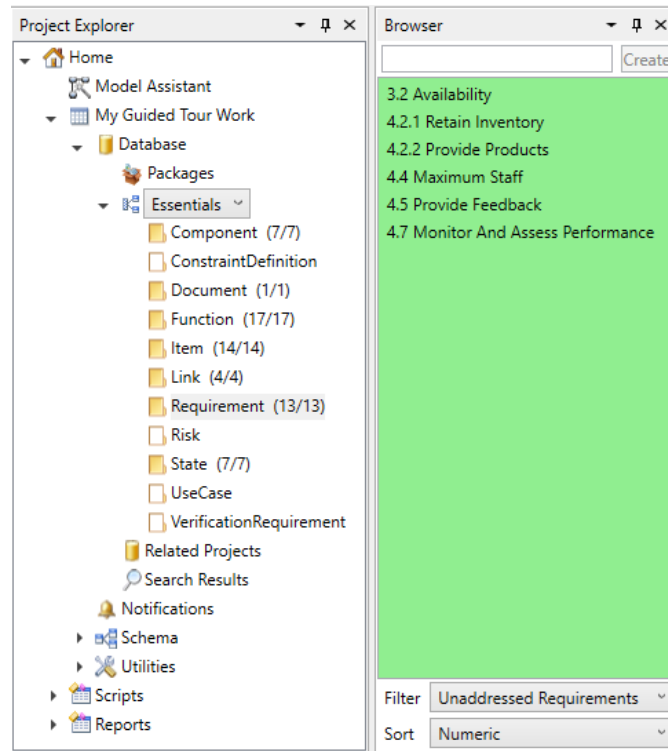

Selecting the Scripting Language

GENESYS users can select the scripting language, in *User Preferences*, to use in GENESYS.

1. Access *User Preferences* by selecting the **File** menu, then clicking the **Preferences** button at the bottom right side of the menu that appears.

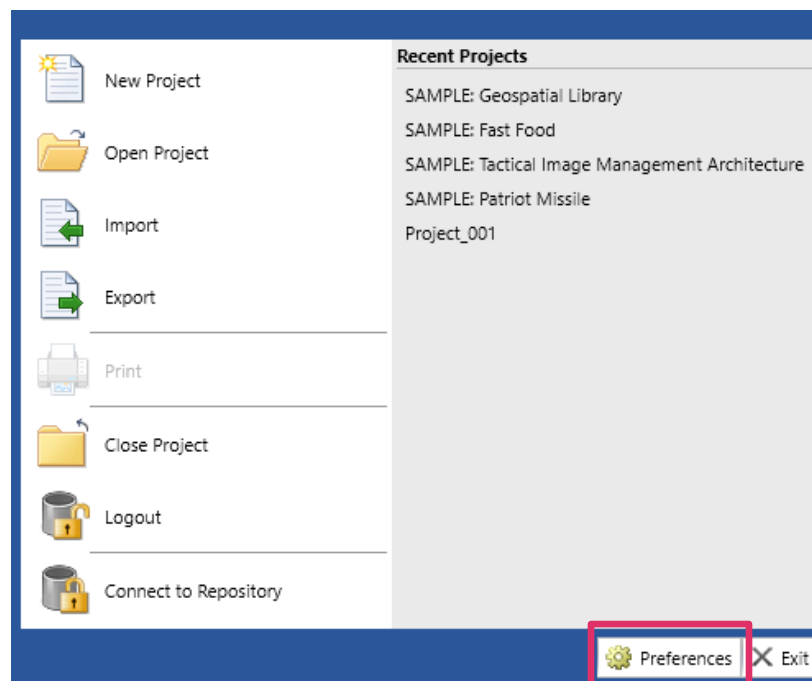

Systems Engineering Guided Tour

2. Under *User Preferences*, select the *General* preferences.

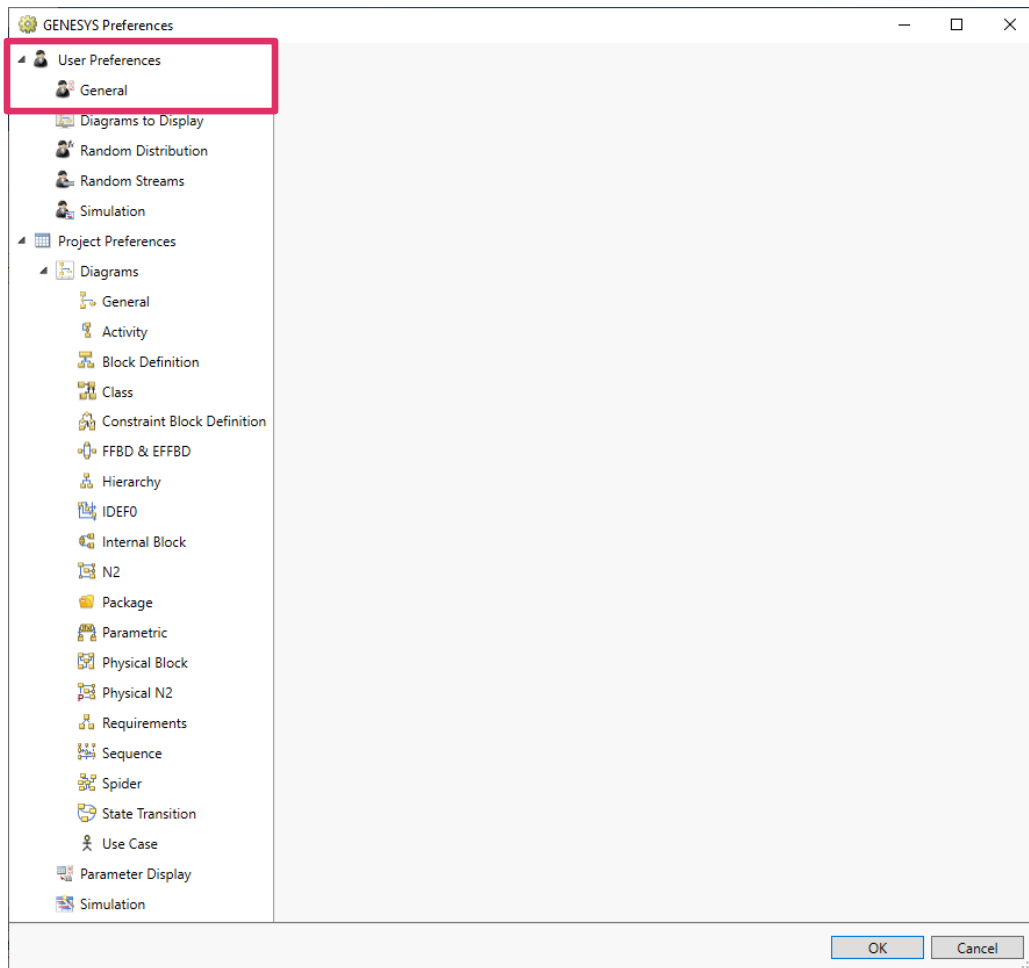

3. In the *General Options* section of the window that displays, select the scripting language from the drop-down list on the **Default Script Language** field.

GENESYS supports Visual Basic and C# scripting languages. The default language is Visual Basic.

Systems Engineering Guided Tour

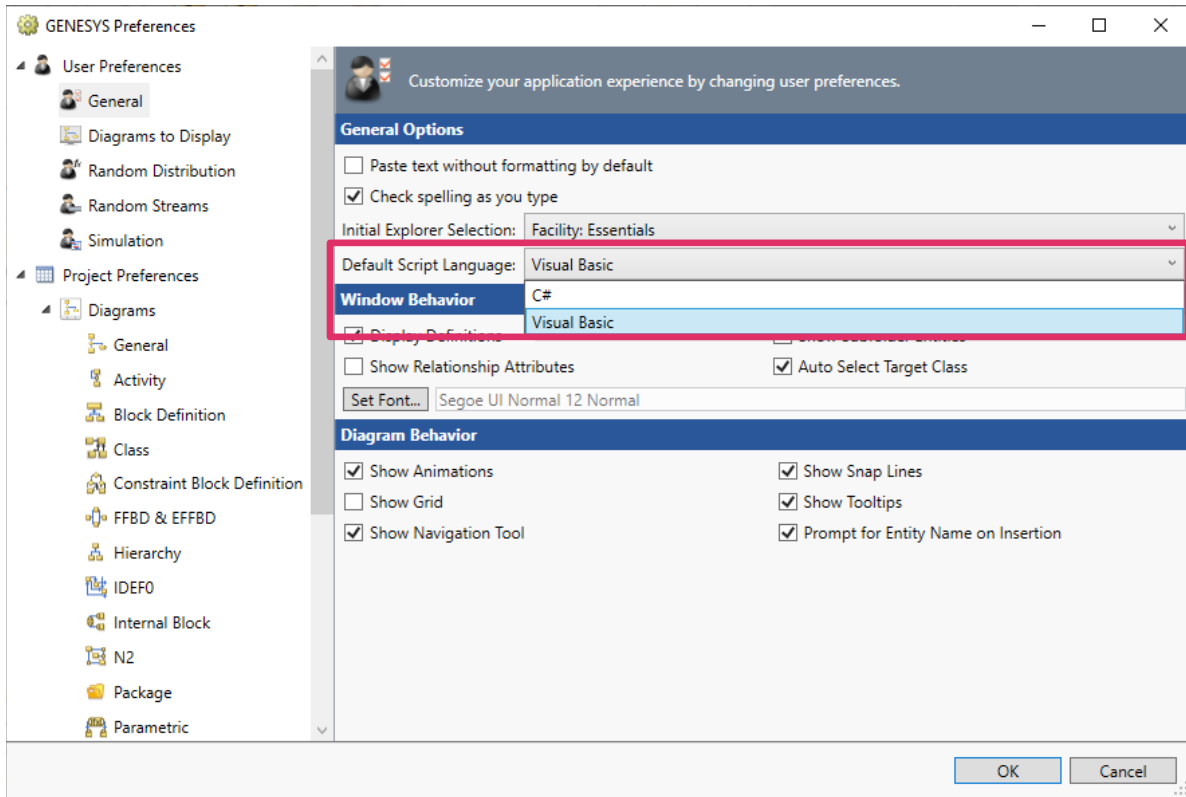

GENESYS users also have the option to select the language when creating a new script.



1. On the *Utilities* tab, select the **Scripts** icon, **New Script**, and then select the language from the **Script Language** drop-down list. This will override the default script language set in *User Preferences*.

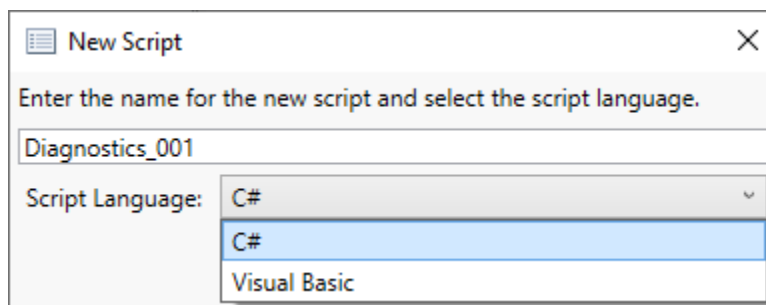

Systems Engineering Guided Tour

The scripting language is also displayed as a read-only field on the script property sheet, as shown below.

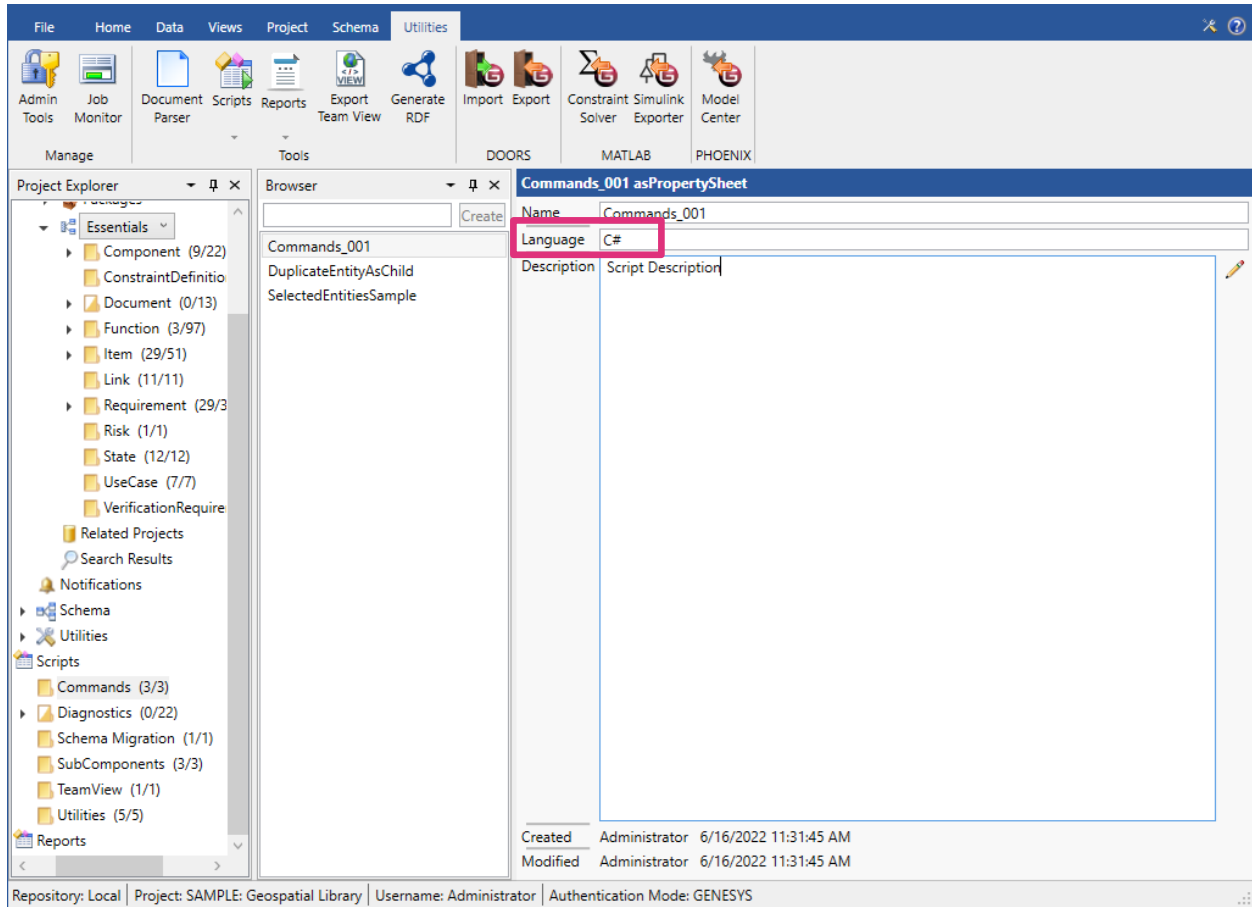

Change Control

GENESYS provides several mechanisms for identifying and tracking changes to the repository. These include Audit Logs, Versioning, and a Project Compare Report.

Audits Logs provide a history of changes to an entity. When a new project is created, Audit Logs are enabled by default.

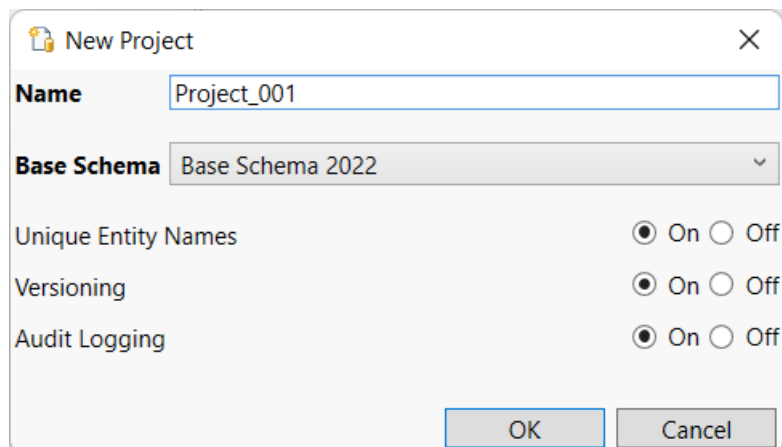

Systems Engineering Guided Tour

The Audit Log is accessed through a property sheet's **Properties** tab.

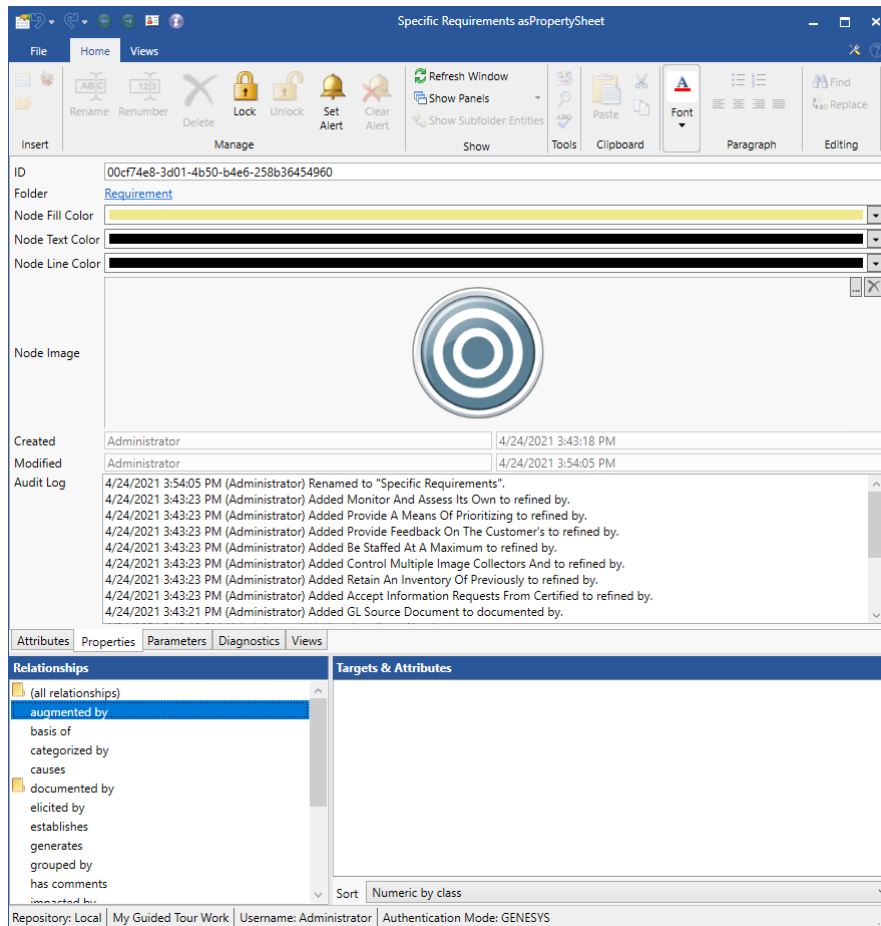

The log identifies when the change was made, by whom, and the nature of the change. Versioning provides a more detailed view of changes to an entity's attributes. When an attribute is changed the **Version Browser** icon becomes highlighted. Select the icon  to open a Versioning dialog.

The dialog identifies when the change was made, by whom, and the attribute's value. The bottom value is the entities baseline. The top value is the entities current value. Pressing the **Restore** button makes the highlighted value the current value with its original timestamp.

In the **Project** tab of the ribbon, you'll find the commands to **Purge Versions** and **Baseline Versions**. **Purge Versions** removes all interim values leaving the current and baseline values. **Baseline Versions** removes all values except the current, which becomes the baseline. These apply to the entire project. Selective purging and baselining can be done using the **Purge Versions** and **Baseline Version** commands from the entity right-click menu. The Attribute History Report prints the version history for selected entities and attributes.

There is another report known as Project Compare. This report is a comprehensive comparison of two projects. It lists new and deleted entities, changes to attributes and relations, and identifies when a diagram has been modified.

7. CREATING CUSTOMIZED VIEWPOINTS OF THE DATA MODEL

GENESYS users can create customized perspectives of a project model's data that address sets of stakeholder concerns. These perspectives, called Viewpoints, are like reusable queries that define the content and rules for constructing a view of the model. They can incorporate the specialized language of any profession or stakeholder community. A view is a representation of the system from the perspective of a single viewpoint.

When GENESYS applies a viewpoint to a set of entities, GENESYS outputs the desired properties, attributes, parameters, relationships, and relationship attributes.

A viewpoint consists of one or more masks, mappings, and filters, as described next.

Masks

The Masks feature provides the capability to hide entities, attributes, parameters, parameter fields, properties, and/or relationships, enabling you to focus only on the subset of the schema that the audience for your viewpoint needs to see.

To access the Masks feature in GENESYS, click the arrow next to *Utilities* in the *Project Explorer* pane and then select *Masks*.

The available masks, if any, are displayed in the *Browser* pane.

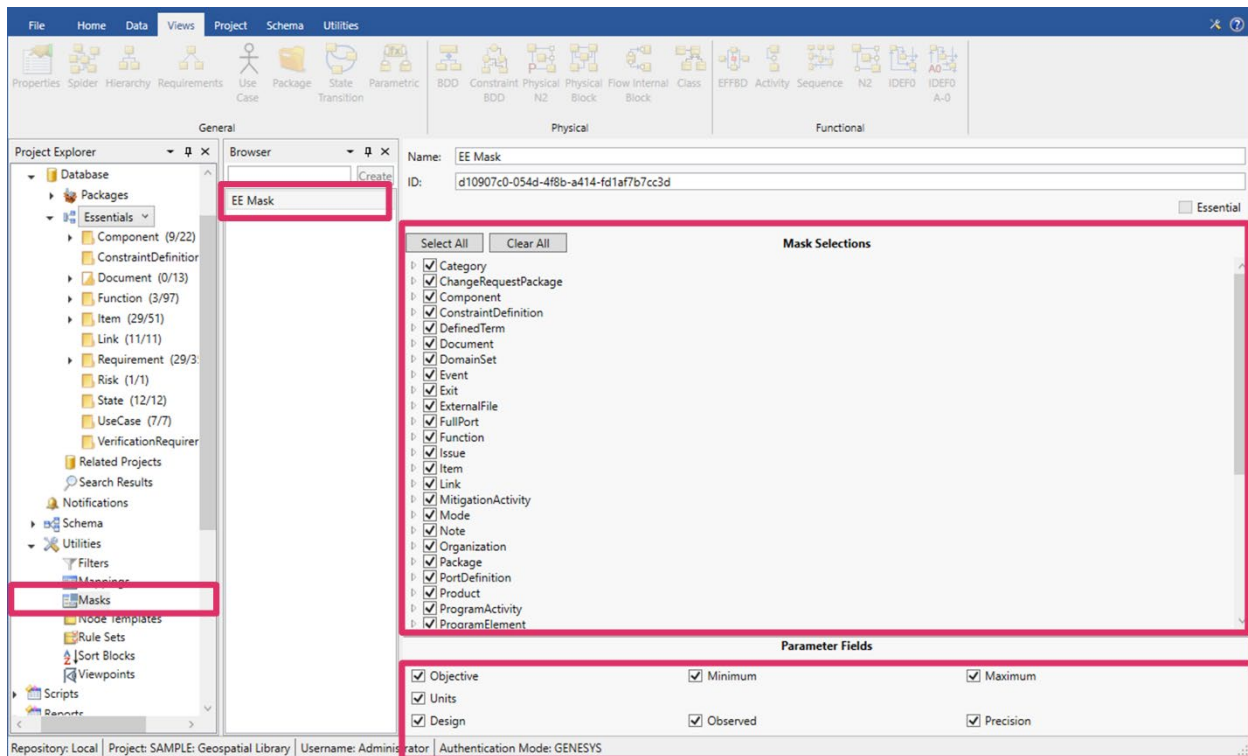

Creating a New Mask

To create a new mask:

1. Enter a name for the new mask in the box at the top of the *Browser* pane and then click **Create**. Alternatively, right-click in the *Browser* pane and select *New Mask* from the drop-down list that appears, and then enter a name for the new mask in the window that displays.

Systems Engineering Guided Tour

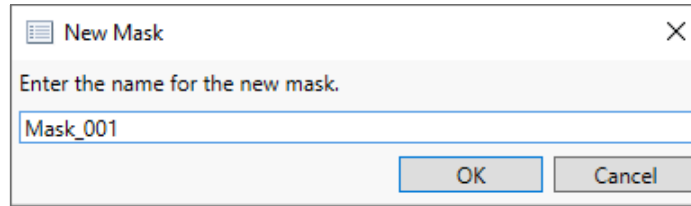

The new mask appears in the pane.

2. All the entities, attributes, parameters, properties, and relationships in the project appear in the Mask Selections section in the center of the window. Select the items to include in the mask.
Choose Select All or Clear All to select or clear all the items at once, respectively.
3. Select the fields to include as parameters in the mask in the Parameter Fields section at the bottom of the window. Available parameter fields include objective, minimum, maximum, units, design, observed and precision.

Deleting a Mask

To delete a mask:

1. Right-click on the mask that you want to delete in the *Browser* pane and select *Delete* on the drop-down menu that appears or click the **Delete** key on your keyboard.

The mask disappears from the list.

Mappings

The Mappings feature provides the capability to translate terms (i.e., class names, attribute names, parameter names, relationship names, relationship attribute names, parameter fields, etc.) used in GENESYS to the specialized language of particular disciplines or stakeholder communities. For instance, for an electrical engineer, the word “item” can be mapped to the word “signal” and the word “link” can be mapped to the word “trace”, etc.

To access the Mappings feature in GENESYS, click the arrow next to *Utilities* in the *Project Explorer* pane and then select *Mappings*.

Systems Engineering Guided Tour

The available mappings are displayed in the *Browser* pane.

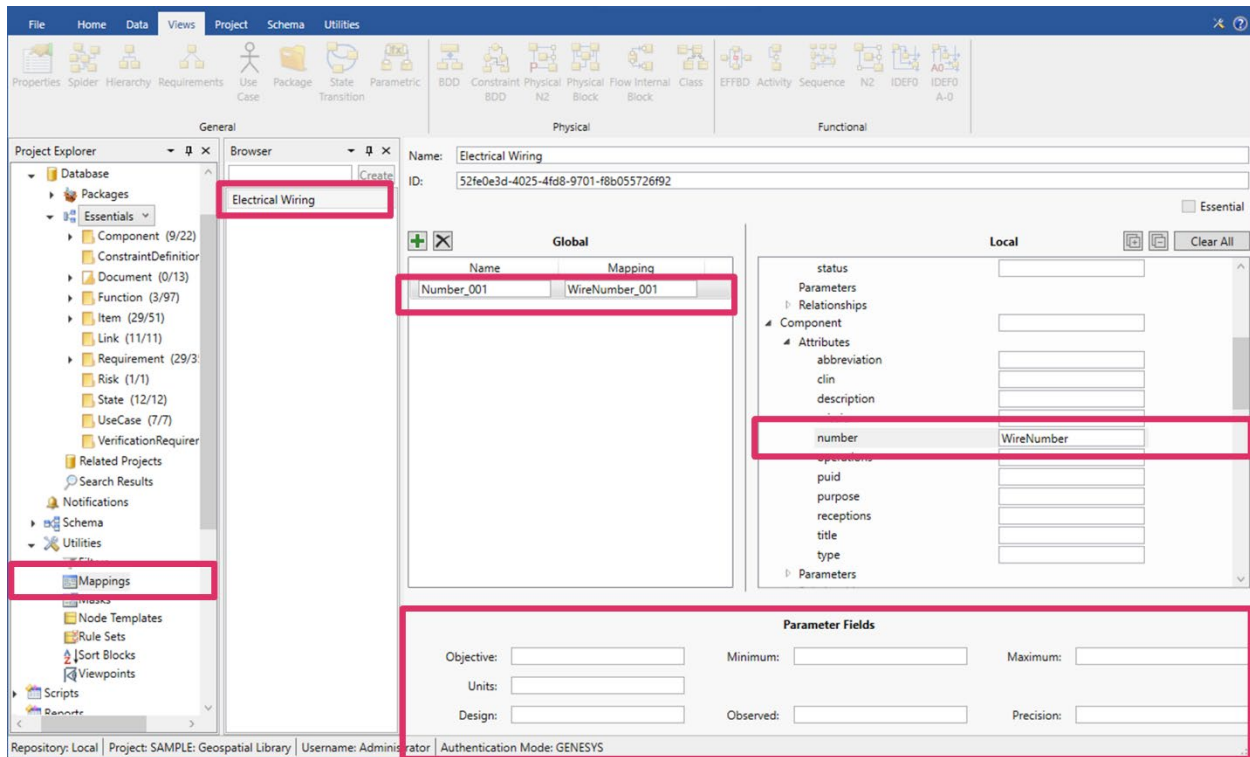

Creating a New Mapping

To create a new mapping:

1. Enter a name for the new mapping in the box at the top of the *Browser* pane and then click **Create**. Alternatively, right-click in the *Browser* pane and select *New Mapping* from the drop-down menu that appears, and then enter a name for the new mapping in the window that displays.

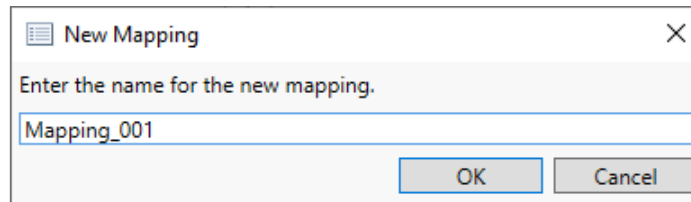

The new mapping appears in the *Browser* pane.



Creating a New Global or Local Mapping Item

To create a new global or local mapping item:

1. Select the green **Insert**  icon at the top of the *Global* pane in the center of the window. A new mapping item appears in the pane. The original name for the item appears on the left side and the new mapping name appears on the right side. You have the option to keep the default name for the mapping item, **Mapping_###**, or rename it. This section of the window is for specifying global mappings that will globally replace the specified definition names every place that they appear in the viewpoint.

Systems Engineering Guided Tour

2. You can also specify local mappings that take precedence over the global mappings and apply only to the specified definition. In the *Local* pane on the right side of the window, click the arrows next to the items that you want to map and next to any attributes, relationships, etc. under these items. To define a local mapping, scroll through the GENESYS items and rename any of them with specialized language. In the example above, we renamed “number” to “WireNumber” in the Electrical Wiring mapping.

To expand all the items in the *Local* section at once, click the **Expand All**  icon on the top right side of the window section, or to collapse all the items, select the **Collapse All**  icon.

To clear all the items that you selected, select *Clear All* on the top right side of the window section.

3. You also have the option to rename any of the parameter fields in the *Parameter Fields* section at the bottom of the window.

Deleting a Mapping Item

To delete a mapping item:

1. Highlight the mapping item that you want to delete and select the **Delete**  icon at the top of the *Mapping Items* pane.

The mapping item disappears from the list.

Deleting a Mapping

To delete a mapping:

1. Right-click on the mapping that you want to delete in the *Browser* pane and select *Delete* on the drop-down menu that appears or click the **Delete** key on your keyboard.

The mapping disappears from the list.

Filters

With a filter, you can narrow a large amount of data down to the specific data that you want.

To access the filters in GENESYS, click the arrow next to *Utilities* in the *Project Explorer* pane and then select *Filters*.

The available filters display in the *Browser* pane.

Systems Engineering Guided Tour

Highlight the filters that you want in the *Browser* pane.

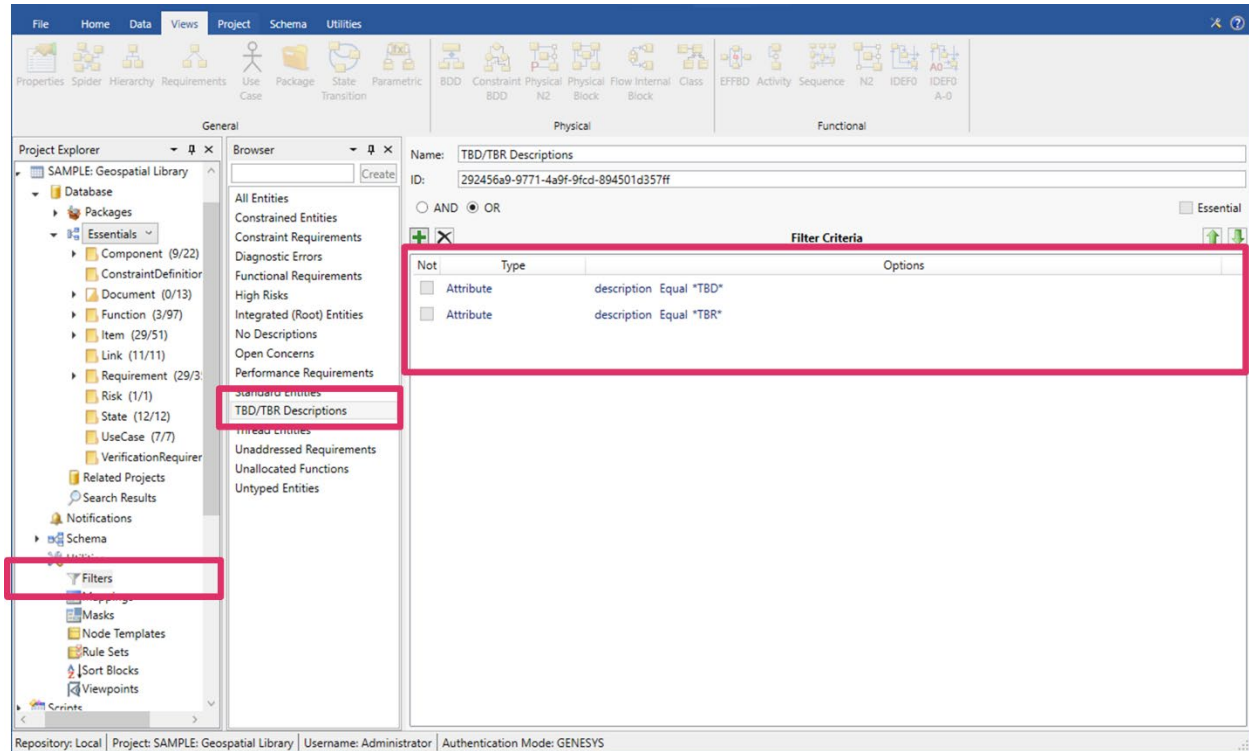

Creating a New Filter

To create a new filter:

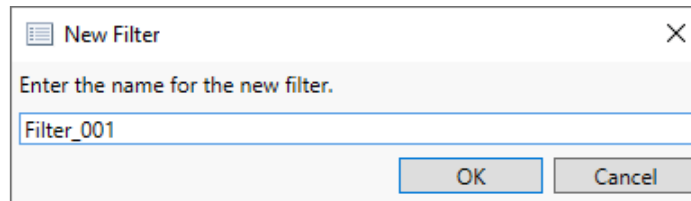

1. Enter a name for the new filter in the box at the top of the *Browser* pane and then click **Create**. Alternatively, right-click in the *Browser* pane, select **New Filter** from the drop-down menu that appears, and then enter a name for the new filter in the window that displays.



The new filter appears in the pane.

2. Filter criteria for the selected filter displays in the *Filter Criteria* section of the window.
3. Select **AND** or **OR** at the top of the *Filter Criteria* section to form a logical **AND** or **OR** statement, respectively, for the filter criteria.
4. Select the criteria that you want to apply to the filter, and depending on the options that you select, enter values or select additional options or operators to specify the criteria for the filter.
5. To add additional criteria to the filter, click the green **Insert**  icon at the top of the *Filter Criteria* section, or right-click a filter criterion and select **Add Filter Criterion** from the drop-down menu that appears, and then specify the additional filter criteria.

Sorting Filter Criteria

1. To sort filter criteria in a different order, highlight a filter criterion in the window and click the green **Move Up**  or **Move Down**  arrow to move the filter criterion up or down, respectively, in the list. Alternatively, right-click on the filter criterion and select the **Move Up** or **Move Down** arrows from the drop-down menu that appears.



Deleting Filter Criteria

To delete filter criteria:

1. Highlight the filter criterion that you want to delete and click the **Delete**  icon at the top of the *Filter Criteria* section, or right-click on the filter criterion and select *Remove Filter Criterion* on the drop-down menu that appears.

The filter criterion disappears from the list.

Deleting a Filter

To delete a filter:

1. Right-click on the filter that you want to delete in the *Browser* pane and select *Delete* on the drop-down menu that appears or click the **Delete** key on your keyboard.

The filter disappears from the list.

NOTE: If the *Essential* checkbox on the top right corner of the *Mask/Mappings/Viewpoint/Filter* window is checked, this indicates that the selected mask/mappings/viewpoint/filter is essential to the model and cannot be deleted. Normally, this option can only be set by the GENESYS Team and GENESYS users do not set it.

Viewpoints

To access the Viewpoints feature in GENESYS, click the arrow next to *Utilities* in the *Project Explorer* pane and then select *Viewpoints*.

The available viewpoints are displayed in the *Browser* pane.

Systems Engineering Guided Tour

Highlight the viewpoint that you want to view, in the *Browser* pane.

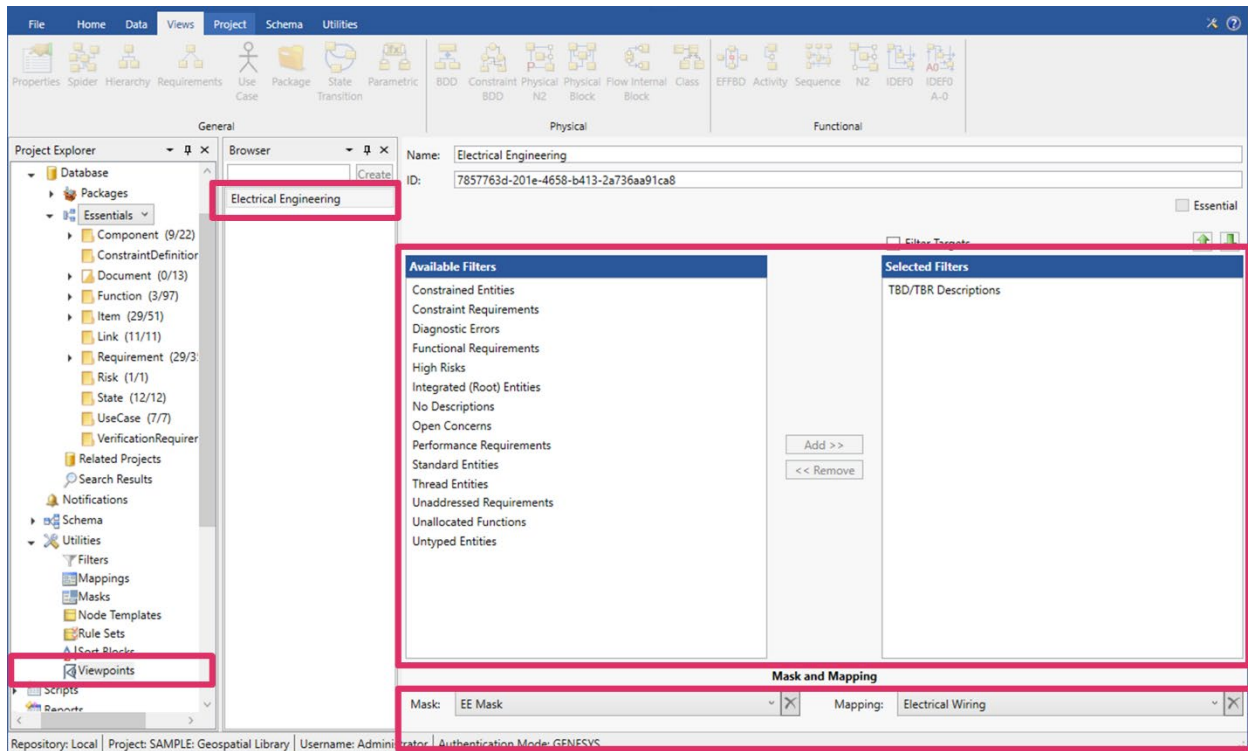

Creating a New Viewpoint

To create a new viewpoint

1. Enter a name for the new viewpoint in the box at the top of the *Browser* pane and then click **Create**. Alternatively, right-click in the *Browser* pane and select *New Viewpoint* from the drop-down menu that appears, and then enter a name for the new viewpoint in the window that displays.

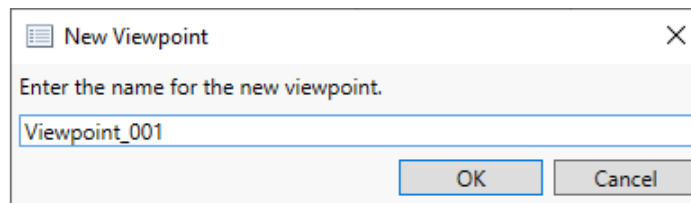

The new viewpoint appears in the pane.

2. Select filters to apply to the viewpoint by highlighting them in the *Available Filters* section in the center of the window and clicking **Add**. The selected filters will appear in the *Selected Filters* box on the right side of the window.



To remove any filters, highlight them in the *Selected Filters* section on the right side of the window and click **Remove**.

3. Check the *Filter Targets* checkbox at the top of the *Available Filters* window section if you want to include only entities that satisfy all filters in the resulting data set.
4. Select the mask and mapping to use for the selected viewpoint in the *Mask and Mapping* section at the bottom of the window.

Systems Engineering Guided Tour

To delete the mask or mapping that you selected, click the **Delete**  icon next to the Mask or Mapping field.

Sorting Filters

To sort the filters you selected in a different order, highlight the filter and click the green **Move Up**  or **Move Down**  arrow to move the filter up or down, respectively, in the list.

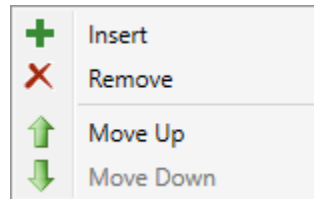

Deleting a Viewpoint

To delete a viewpoint:

1. Right-click on the viewpoint that you want to delete in the *Browser* pane and select *Delete* on the drop-down menu that appears or click the **Delete** key on your keyboard.

The viewpoint disappears from the list.

NOTE: Masks, mappings, and viewpoints can be imported and exported into other projects.

Rule Sets

Rule sets enable users to create rules for automatically formatting many features of a diagram. Applying a rule set to a diagram significantly saves time in creating and maintaining diagrams.

To access rule sets in GENESYS, click the arrow next to **Utilities** in the *Project Explorer* pane and then select *Rule Sets*.

Systems Engineering Guided Tour

The available rule sets display in the *Browser* pane.

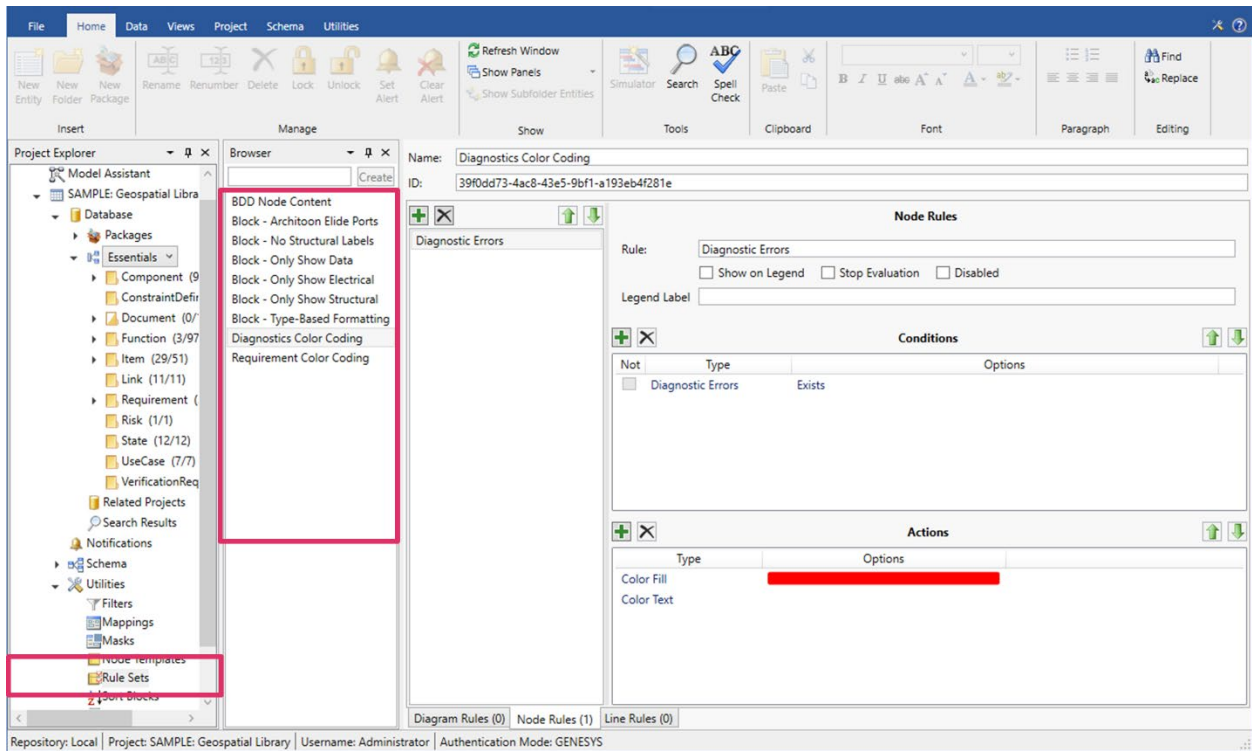

Highlight the rule set that you want to view, in the *Browser* pane, and then select the **Diagram Rules**, **Node Rules**, or **User Rules** tab at the bottom of the *Rules* pane, to access the available diagram rules, node rules, or user rules, respectively, for that rule set.

Systems Engineering Guided Tour

The available rules for that rule set display in the *Rules* pane, as shown below:

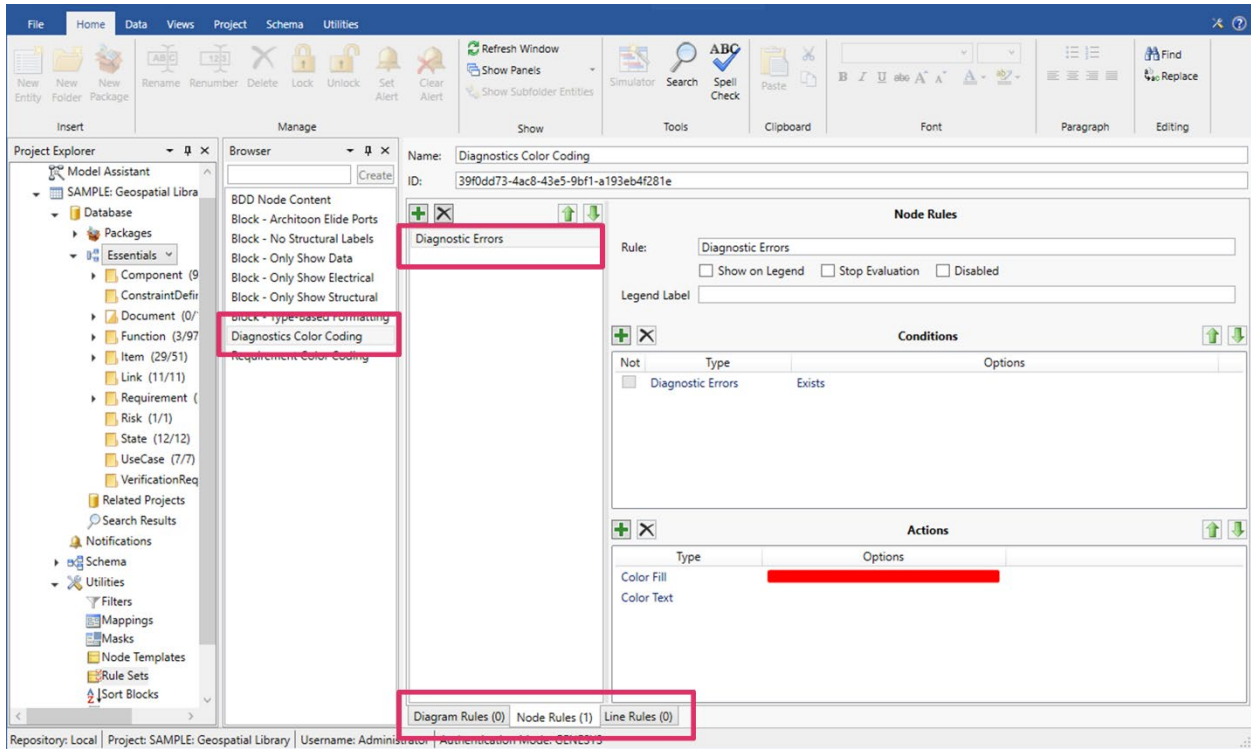

Highlight the rule that you want to view.

In the screen above, the Diagnostic Errors rule colors the background of any nodes on the diagram that contain diagnostic errors in red.

Creating a New Rule Set

To create a new rule set:

1. Enter a name for the new rule set in the box at the top of the *Browser* pane and then click **Create**. Alternatively, right-click in the *Browser* pane, select *New Rule Set* from the drop-down menu that appears, and then enter a name for the new rule set in the window that displays.

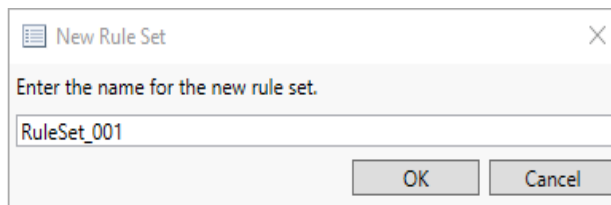

The new rule set appears in the pane.

Deleting a Rule Set

To delete a rule set:

1. Right-click on the rule set that you want to delete in the *Browser* pane and select *Delete* on the drop-down menu that appears or click the **Delete** key on your keyboard.

The rule set disappears from the list.

Creating a New Rule

To create a new rule:

1. Make sure that the rule set for which you are creating a new rule is highlighted in the *Browser* pane.
2. Select the **Diagram Rules**, **Node Rules**, or **User Rules** tab at the bottom of the *Rules* pane, to create a diagram rule, node rule, or user rule, respectively.
3. Select the green **Insert**  icon at the top of the *Rules* pane, or right-click on a rule listed in the pane and select **Insert** from the drop-down menu that appears.

A new rule appears in the pane with the default name “Rule_###”.

4. In the *Diagram/Nodes/User Rules* section on the right side of the window, enter a new name for the rule or keep the default name.

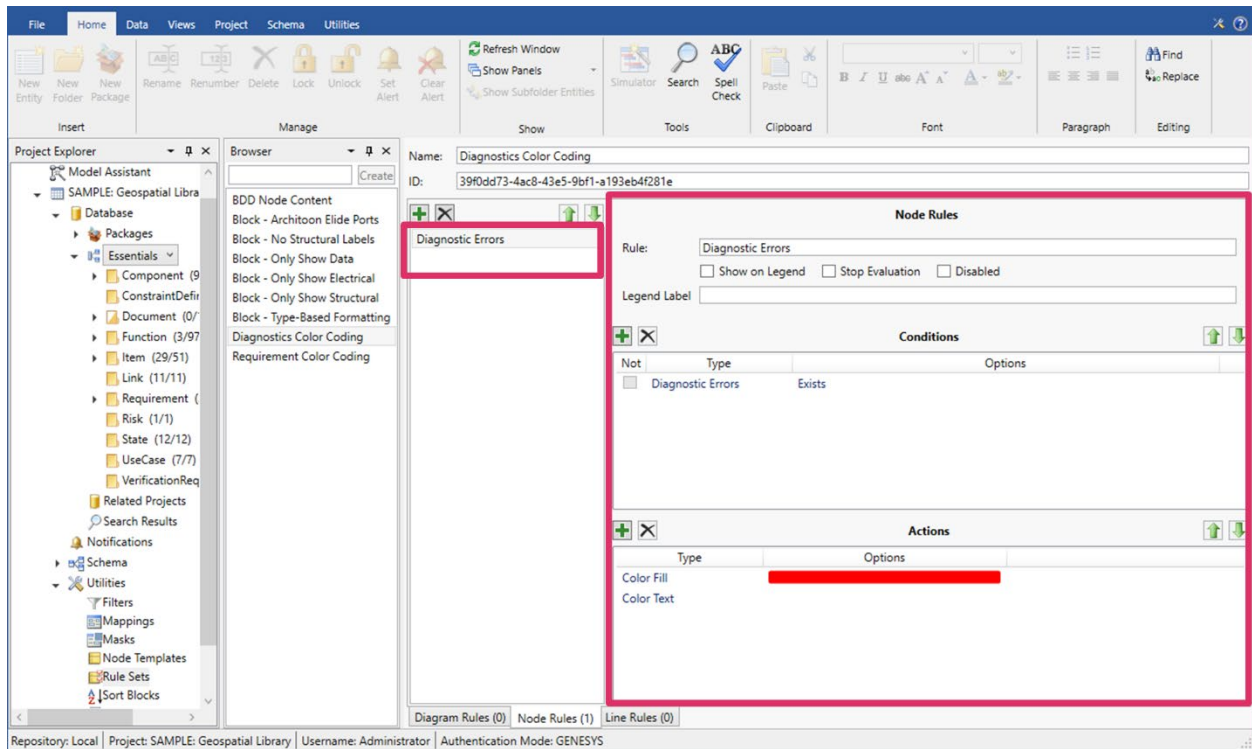

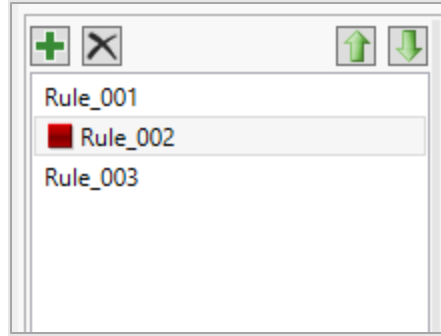

5. Select the checkboxes next to *Show on Legend*, *Stop Evaluation* and *Disabled*, for any options that you want.
6. If you select *Show on Legend*, enter a label for the legend in the *Legend Label* box.
If you select *Stop Evaluation*, the rule will appear with a red block next to it in the window. Since the rules are executed in the model in the order that they are listed in the window, this indicates that the rules will stop executing after Rule_001.

Systems Engineering Guided Tour

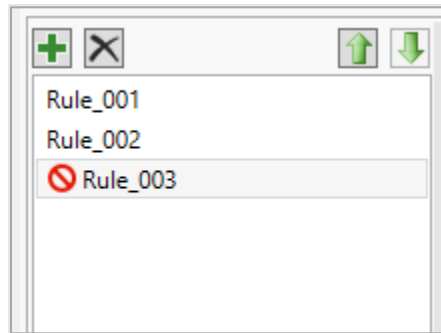

If you select *Disabled*, the rule will be disabled and will appear with a red circle with a line through it in the window.



7. Add a condition to the rule by selecting the green **Insert**  icon in the *Conditions* section of the window, or right-click on a condition listed in the window and select *Insert* from the drop-down menu that appears.
8. To construct the condition, first select the **Type** from the drop-down list. Options include Always, Attribute, Class, Construct, Diagnostic Errors, Node Type, Parameter, Target, or Target Entity.

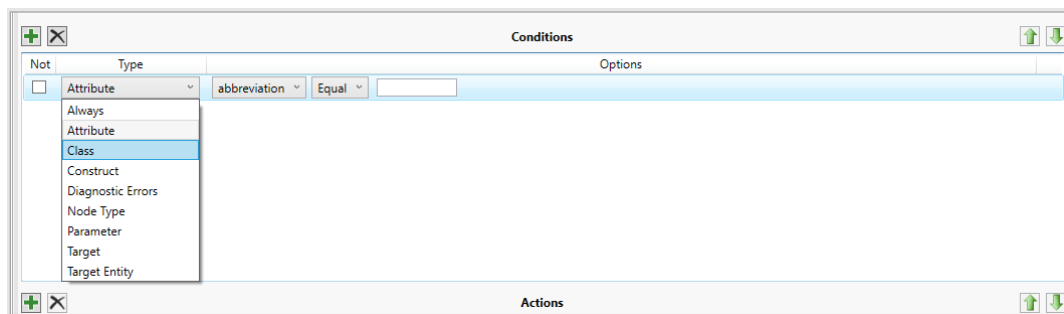

9. Then, depending on what option you selected, select additional options or operators from the drop-down lists to construct a conditional expression that determines what automatic formatting will be applied to the items you selected.
10. Add an action to the rule by selecting the green **Insert**  icon in the *Actions* section at the bottom of the window, or right-click on an action listed in the window and select *Insert* from the drop-down menu that appears. Then select the **Type** from the drop-down list. Options include *Border/Line Style*, *Border/Line Weight*, *Color Fill*, *Color Line*, *Color Text*, *Elision*, *Node Image*, *Node Shape*, *Node Show Image*, *Template*, *Text Bold*, *Text Italic*, or *Text Strikethrough*. Depending on what option you selected, select any additional options.

Systems Engineering Guided Tour



By combining conditions and actions and multiple rules, GENESYS users can automatically format many items in their models.

A few examples are below:



- Show the computer nodes as computer  images on the diagram.
- Show mechanical nodes in the diagram in **purple** and electrical nodes in **yellow**.
- Show external nodes in **black**.
- Show the nodes and connecting lines in **green** if the *Cost* attribute for the nodes is < \$300,000.

Sorting Rules, Rule Conditions or Rule Actions

To sort the rules, rule conditions, or rule actions in a different order, highlight the rule, condition, or action in the window and click the green **Move Up**  or **Move Down**  arrow to move the rule, condition, or action up or down, respectively, in the list. Alternatively, right-click on the rule, condition, or action and select the **Move Up** or **Move Down** arrows from the drop-down menu that appears.

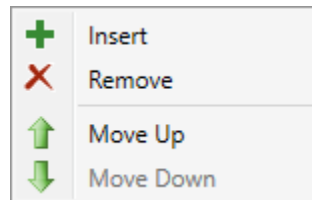

Deleting a Rule, Rule Condition or Rule Action

To delete a rule, rule condition, or rule action:

1. Highlight the rule, condition, or action that you want to delete in the window and select the **Delete**  icon at the top of the *Rules*, *Conditions*, or *Actions* pane, or right-click on the rule, condition, or action and select **Remove** from the drop-down menu that appears.

The rule, rule condition, or rule action disappears from the list.

Duplicating a Mask/Mappings/Viewpoint/Filter/Rule Set

To duplicate a mask/mappings/viewpoint/filter/rule set:

1. Right-click on the mask/mappings/viewpoint/filter/rule set that you want to duplicate in the *Browser* pane of the *Mask/Mappings/Viewpoint/Filter/Rule Set* window and select **Duplicate** on the drop-down menu that appears.

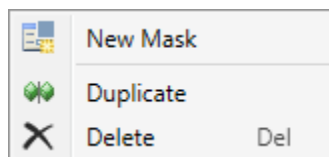

A copy of the mask/mappings/viewpoint/filter/rule set with the same content appears in the *Browser* pane.

The duplicate feature saves time when you want to create a new mask/mappings/viewpoint/filter/rule set that contains similar content to ones already created. After it is created, you can customize the new mask/mappings/viewpoint/filter/rule set.

Applying a Rule Set to a Diagram

To apply a rule set to a diagram, open the diagram and in the **Properties** tab of the diagram Toolbox, select the rule set from the **Rule Set** drop-down list.

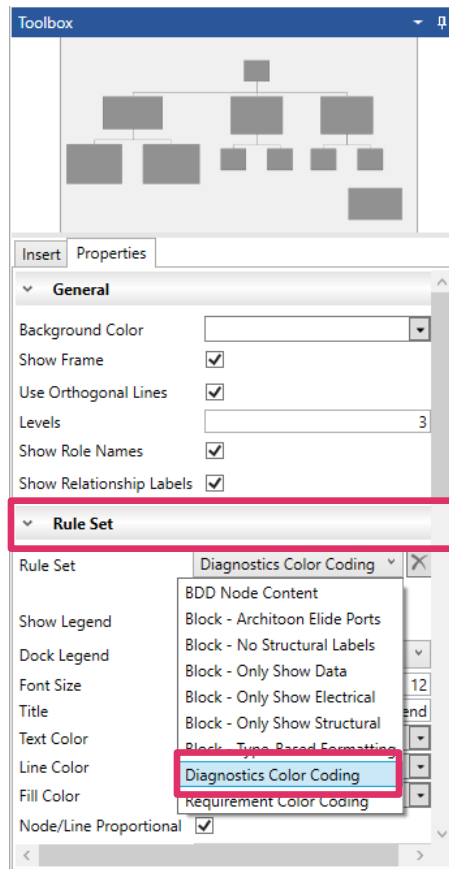

The image below shows the Diagnostic Color Coding rule set applying red color coding to the nodes with errors in the Constraint Block Definition Diagram (BDD) of the Geospatial Library.

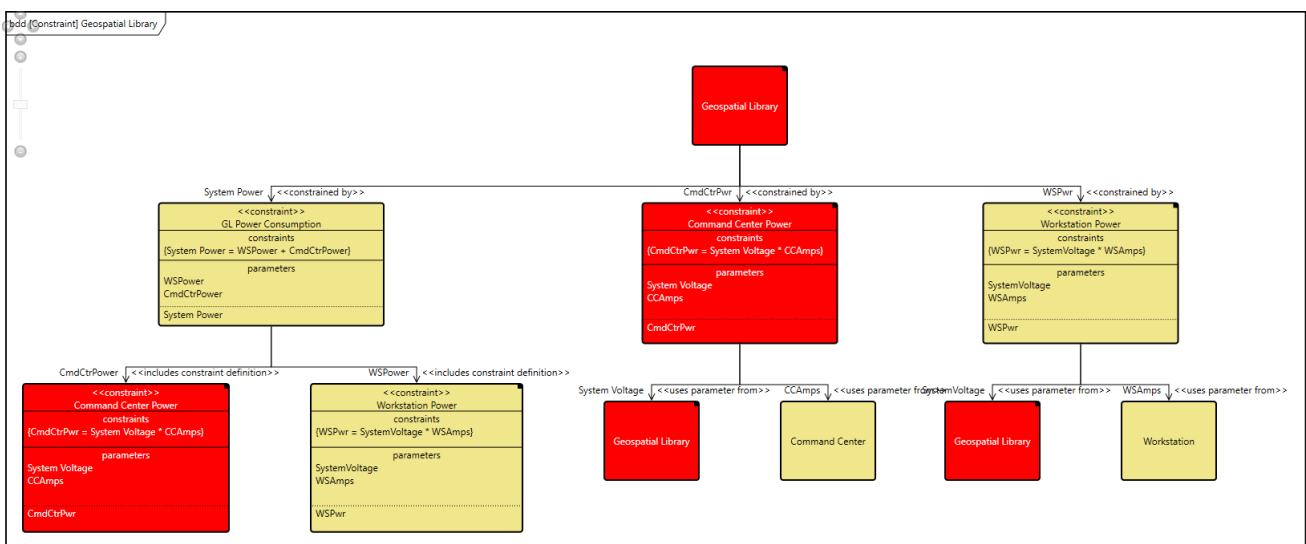

Systems Engineering Guided Tour

If you want to revise a rule or rule set, or create a new one, you can perform this task directly from the diagram Toolbox by selecting *Create* or *Edit* under the Rule Set drop-down.

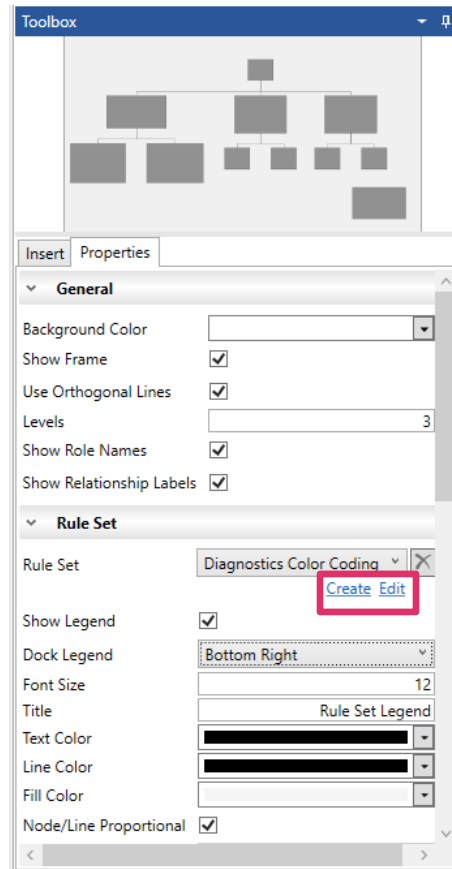

Rule Set Diagram Legends

GENESYS has the capability to add automatically generated legends based on rule sets to diagrams. These legends explain the rule-based formatting of the diagrams. The formatting rules can apply to the entire diagram, all the nodes/lines/other items in the diagram, or to specific nodes/lines/items in the diagram.

These legends add an enormous amount of meaning to the diagrams through visual classification cues, as shown below. At a glance, you can tell that all red blocks on the diagram are diagnostic errors.

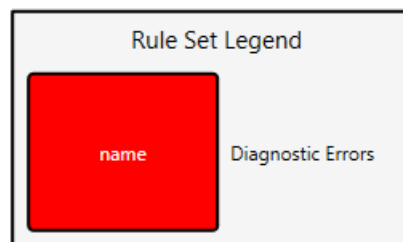

Users also have the option to set many other properties of the rule set legend in the **Properties** tab of the diagram toolbox or in *Project Preferences*, including font size, text/line/fill color, node/line/label width, and node height. Additional options include adding a title to the legend, making the labels the same width as the nodes, and proportionally sizing the nodes and lines. The local settings in the *Toolbox* override the global settings in *Project Preferences*.

Systems Engineering Guided Tour

To add a rule set legend to a diagram, you must first select *Show a Legend* when creating the associated rule set and then check *Show Legend* in the diagram toolbox properties.

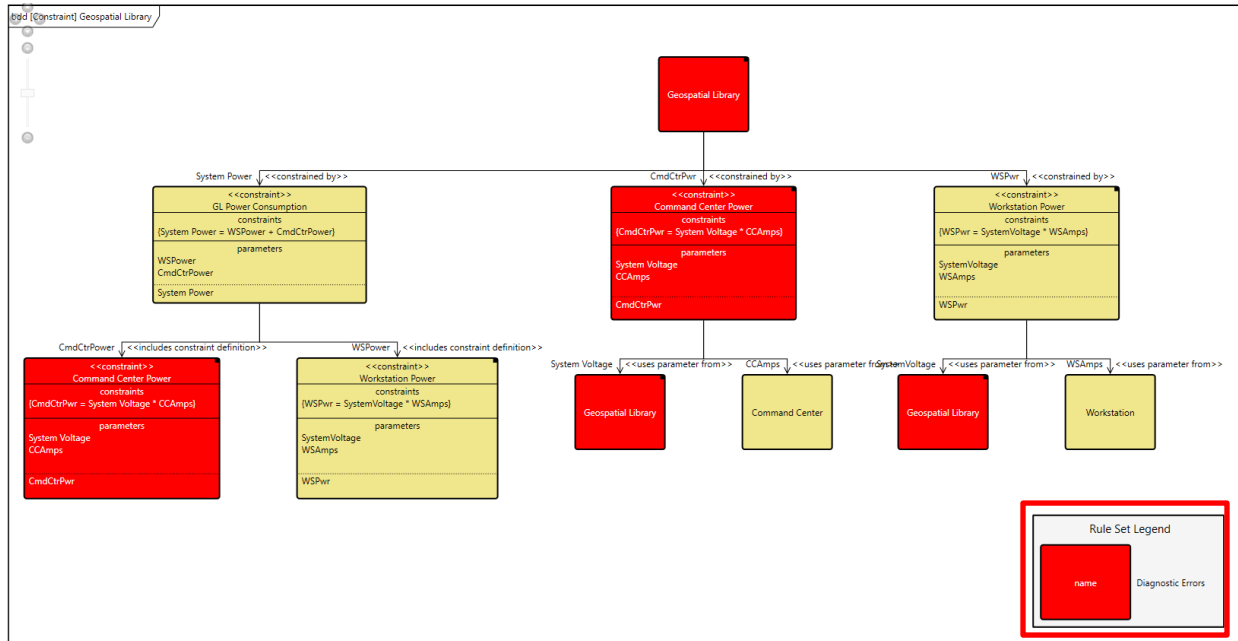

Systems Engineering Guided Tour

By default, the legend is placed on the bottom right side of the diagram, although users can re-position it by selecting another option (bottom left, floating, top left, or top right) from the *Dock Legend* drop-down list in the **Properties** tab of the diagram toolbox. Users can also drag-drop the legend any place on the diagram.

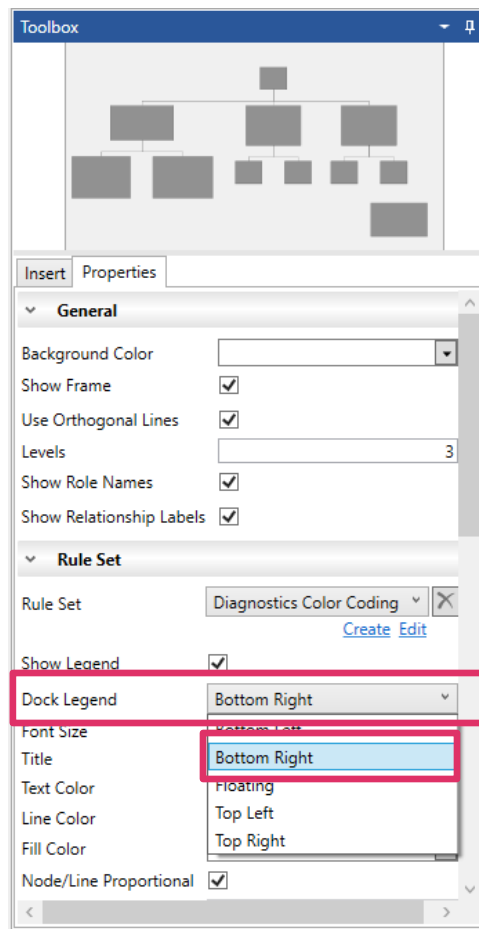

Another example is shown below. The rule sets that apply to this diagram display the node types in assorted colors.

Systems Engineering Guided Tour

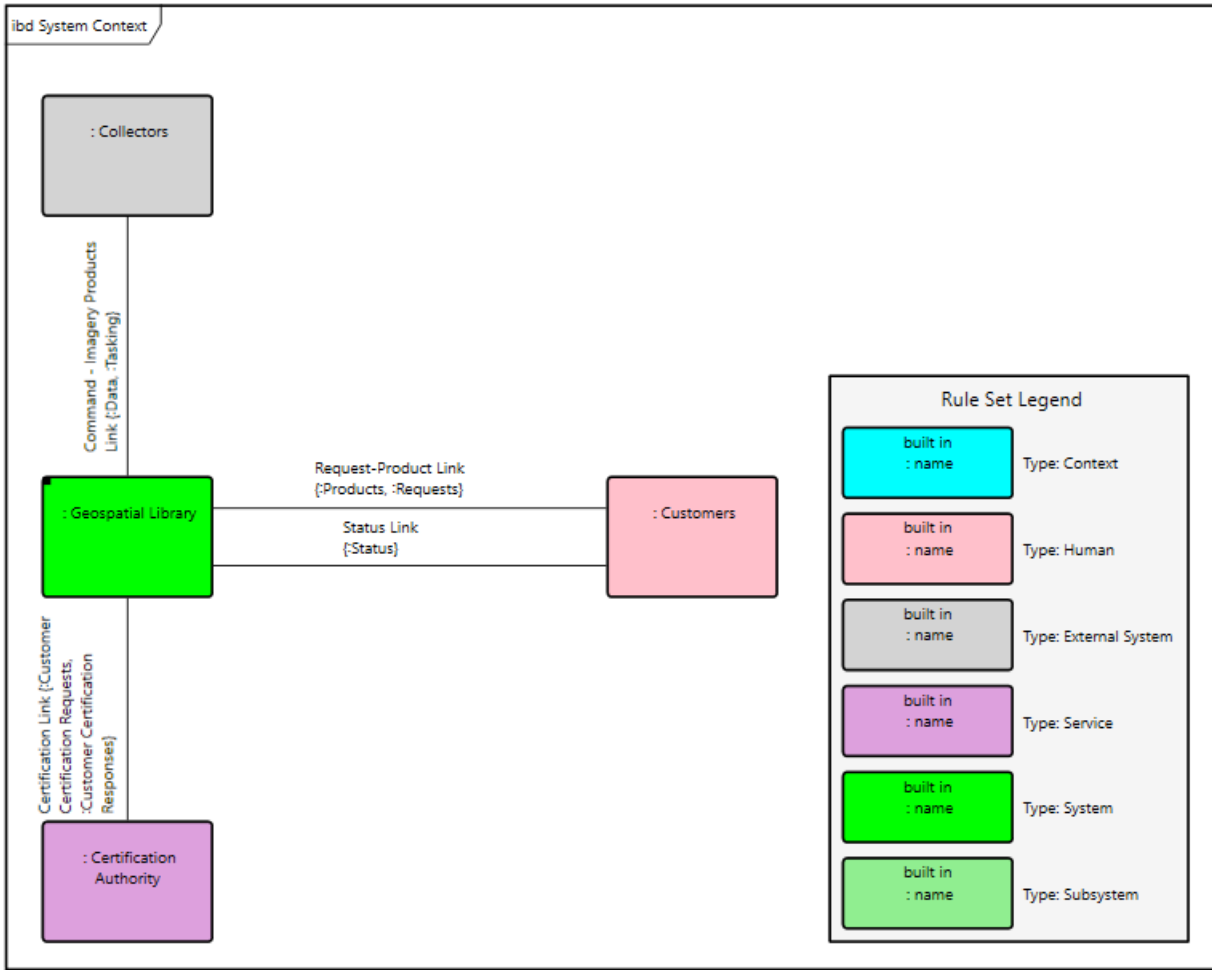

The diagram legend shows at a glance that purple nodes are *services*, and green nodes are *systems* and *subsystems*.

Systems Engineering Guided Tour

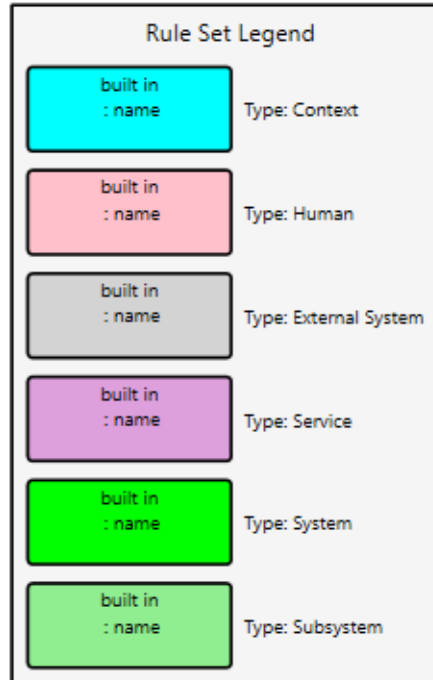

Generating RDF Files with Viewpoints

GENESYS now supports generating Resource Description Framework (RDF) files with viewpoints. The generated RDF files are representations of the GENESYS data and can be processed by tools that use the RDF standard.

The RDF connector, CompressionTurtleWriter, is replacing the former RDF connector in GENESYS since it uses a fuller range of syntax compressions.

Systems Engineering Guided Tour

1. To access this feature, on the *Utilities* ribbon, select **Generate RDF**.

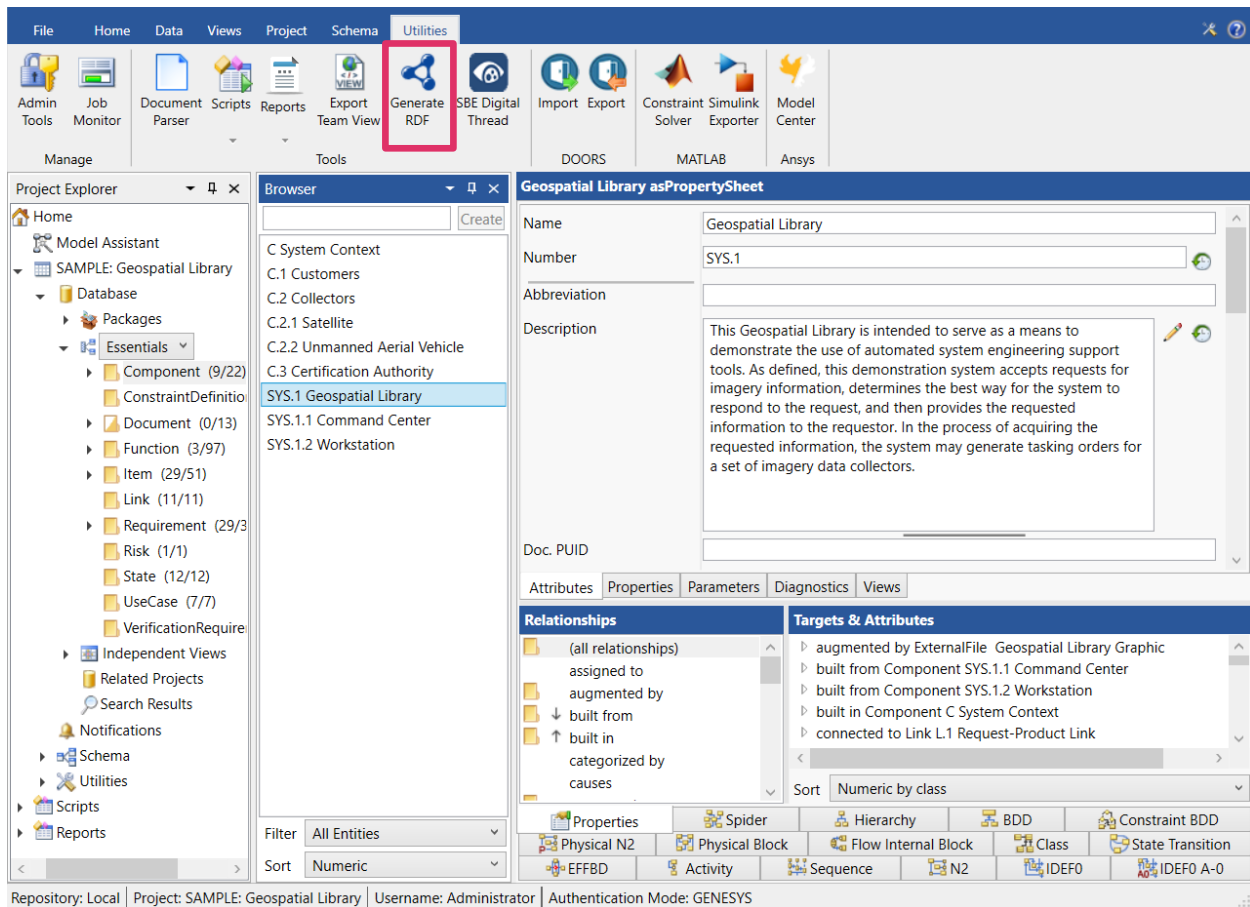

The Generate RDF Wizard displays.

Systems Engineering Guided Tour

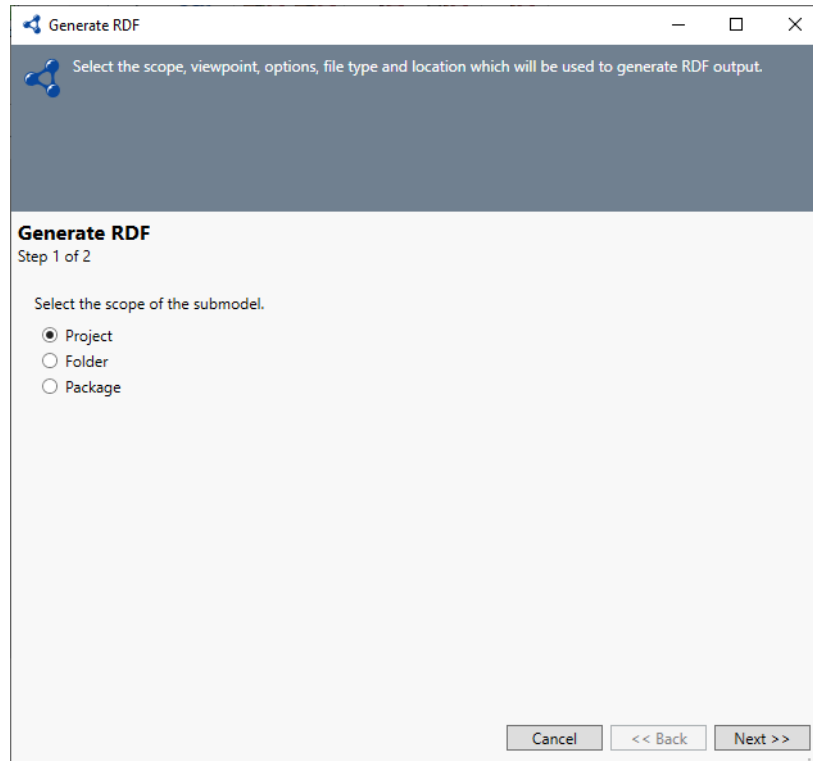

2. At the first window of the wizard, select the scope of the submodel. Options include Project, Folder, or Package. Then click **Next**.

In our sample below, we are selecting Project.

If you select Folder or Package, the available folders or packages in the project appear on the window for you to select, as shown below:

Systems Engineering Guided Tour

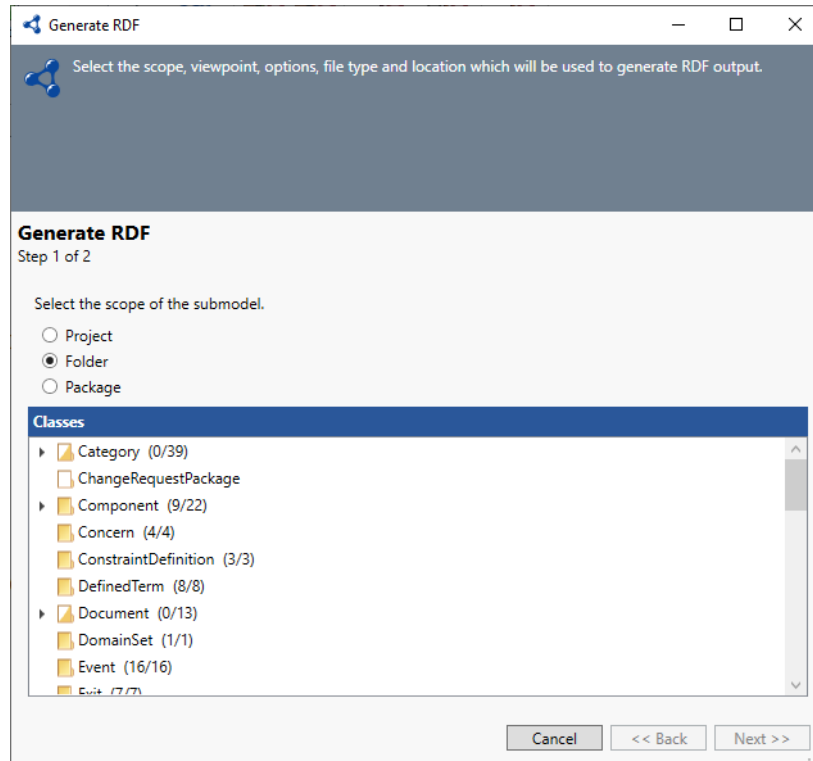

3. At the second wizard window, select a viewpoint.

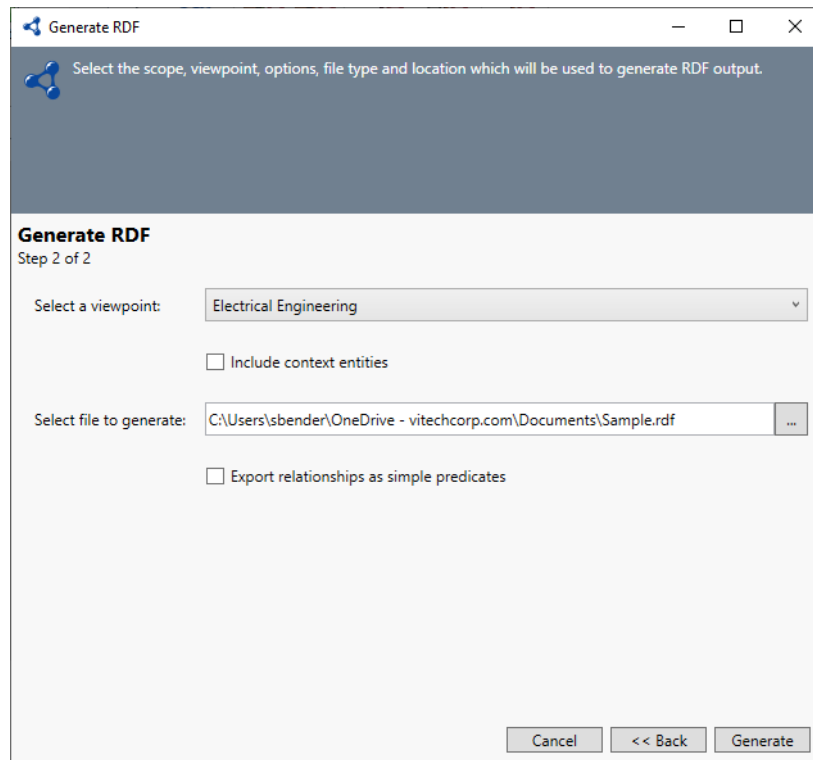

You have the option to select the box to include context entities.

Systems Engineering Guided Tour

4. Enter a name for the generated file, optionally browse to a location to store the file or accept the default location and select a file type.

NOTE: The generate RDF feature in GENESYS supports the two most popular file formats for generating RDF files: RDF (.rdf/xml) and terse RDF triple language (turtle) (.ttl).

You have the option to select the box to export relationships as simple predicates. This will simplify the representation.

CAUTION! When relationships are exported as simple predicates, the relationship attributes will not be included.

5. Click **Generate**.

Access the generated file at the location specified in the window above.

Sample RDF and turtle files are shown below.

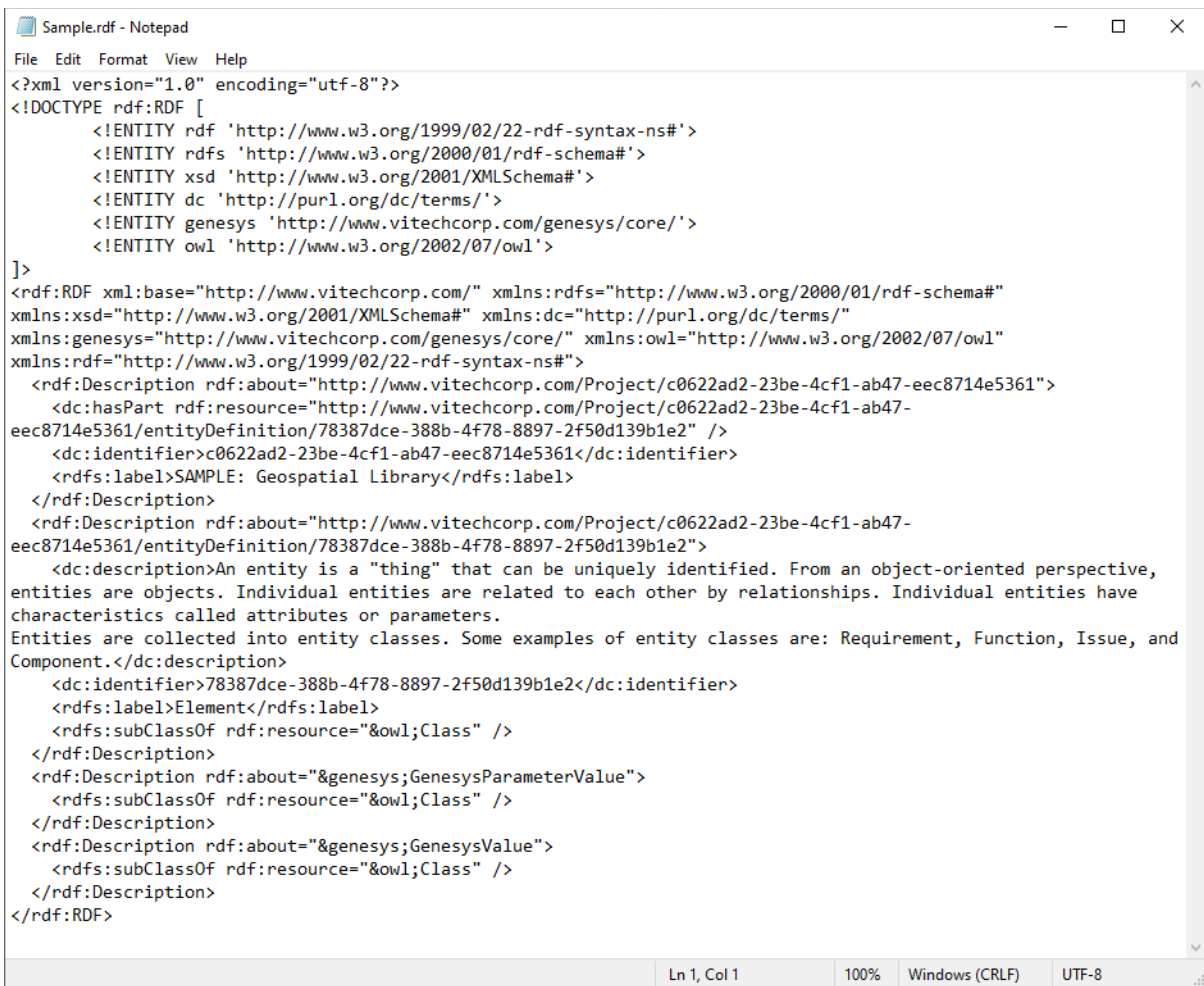

```
Sample.rdf - Notepad
File Edit Format View Help
<?xml version="1.0" encoding="utf-8"?>
<!DOCTYPE rdf:RDF [
  <!ENTITY rdf 'http://www.w3.org/1999/02/22-rdf-syntax-ns#'>
  <!ENTITY rdfs 'http://www.w3.org/2000/01/rdf-schema#'>
  <!ENTITY xsd 'http://www.w3.org/2001/XMLSchema#'>
  <!ENTITY dc 'http://purl.org/dc/terms/'>
  <!ENTITY genesys 'http://www.vitechcorp.com/genesys/core/'>
  <!ENTITY owl 'http://www.w3.org/2002/07/owl'>
]>
<rdf:RDF xml:base="http://www.vitechcorp.com/" xmlns:rdfs="http://www.w3.org/2000/01/rdf-schema#"
xmlns:xsd="http://www.w3.org/2001/XMLSchema#" xmlns:dc="http://purl.org/dc/terms/"
xmlns:genesys="http://www.vitechcorp.com/genesys/core/" xmlns:owl="http://www.w3.org/2002/07/owl"
xmlns:rdf="http://www.w3.org/1999/02/22-rdf-syntax-ns#">
  <rdf:Description rdf:about="http://www.vitechcorp.com/Project/c0622ad2-23be-4cf1-ab47-eec8714e5361">
    <dc:hasPart rdf:resource="http://www.vitechcorp.com/Project/c0622ad2-23be-4cf1-ab47-
eec8714e5361/entityDefinition/78387dce-388b-4f78-8897-2f50d139b1e2" />
    <dc:identifier>c0622ad2-23be-4cf1-ab47-eec8714e5361</dc:identifier>
    <rdfs:label>SAMPLE: Geospatial Library</rdfs:label>
  </rdf:Description>
  <rdf:Description rdf:about="http://www.vitechcorp.com/Project/c0622ad2-23be-4cf1-ab47-
eec8714e5361/entityDefinition/78387dce-388b-4f78-8897-2f50d139b1e2">
    <dc:description>An entity is a "thing" that can be uniquely identified. From an object-oriented perspective,
entities are objects. Individual entities are related to each other by relationships. Individual entities have
characteristics called attributes or parameters.
Entities are collected into entity classes. Some examples of entity classes are: Requirement, Function, Issue, and
Component.</dc:description>
    <dc:identifier>78387dce-388b-4f78-8897-2f50d139b1e2</dc:identifier>
    <rdfs:label>Element</rdfs:label>
    <rdfs:subClassOf rdf:resource="&owl;Class" />
  </rdf:Description>
  <rdf:Description rdf:about="&genesys;GenesysParameterValue">
    <rdfs:subClassOf rdf:resource="&owl;Class" />
  </rdf:Description>
  <rdf:Description rdf:about="&genesys;GenesysValue">
    <rdfs:subClassOf rdf:resource="&owl;Class" />
  </rdf:Description>
</rdf:RDF>
```

RDF FILE

Systems Engineering Guided Tour

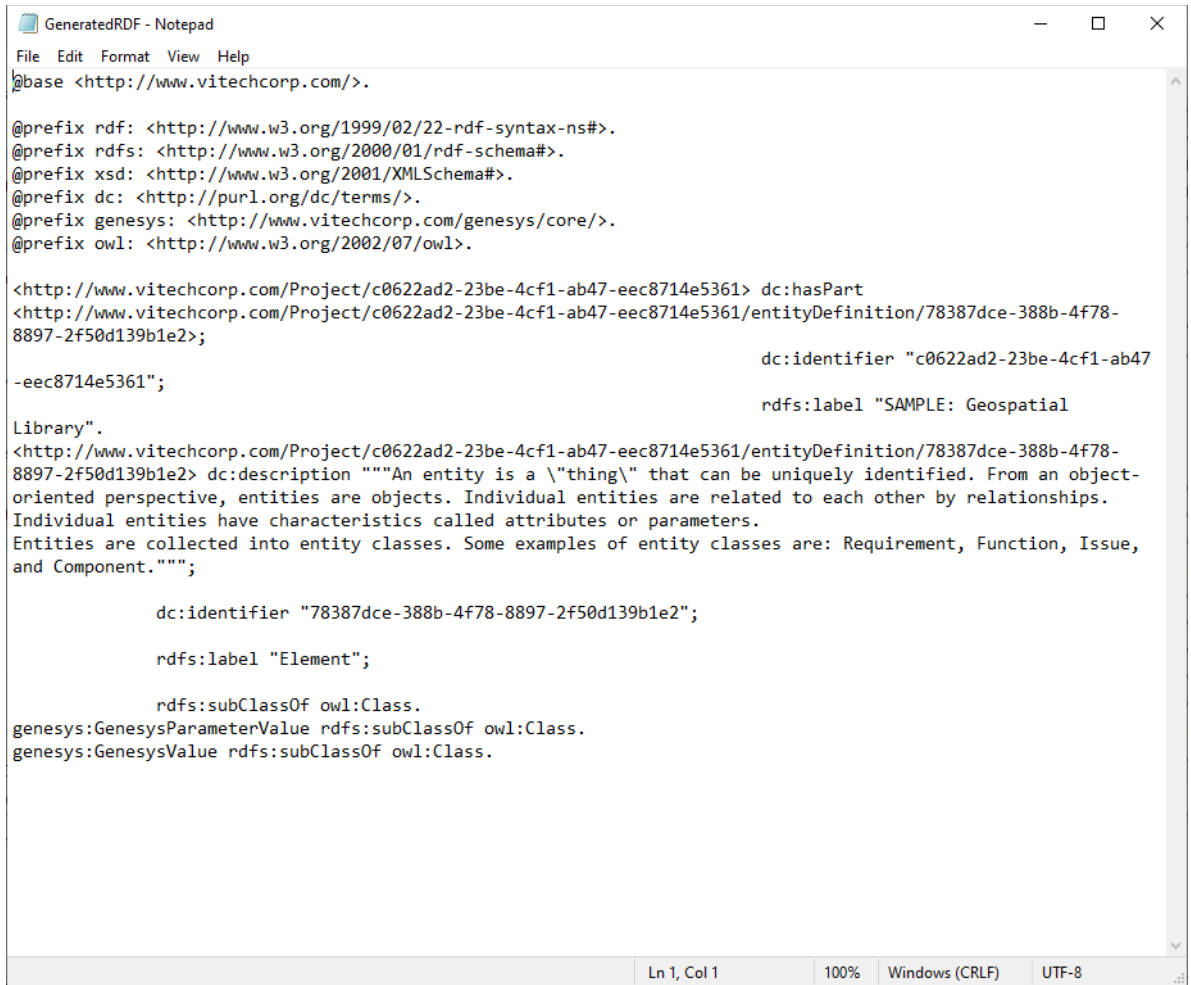

```
GeneratedRDF - Notepad
File Edit Format View Help
@base <http://www.vitechcorp.com/>.

@prefix rdf: <http://www.w3.org/1999/02/22-rdf-syntax-ns#>.
@prefix rdfs: <http://www.w3.org/2000/01/rdf-schema#>.
@prefix xsd: <http://www.w3.org/2001/XMLSchema#>.
@prefix dc: <http://purl.org/dc/terms/>.
@prefix genesys: <http://www.vitechcorp.com/genesys/core/>.
@prefix owl: <http://www.w3.org/2002/07/owl>.

<http://www.vitechcorp.com/Project/c0622ad2-23be-4cf1-ab47-eec8714e5361> dc:hasPart
<http://www.vitechcorp.com/Project/c0622ad2-23be-4cf1-ab47-eec8714e5361/entityDefinition/78387dce-388b-4f78-
8897-2f50d139b1e2>;
                                dc:identifier "c0622ad2-23be-4cf1-ab47
-eec8714e5361";
                                rdfs:label "SAMPLE: Geospatial
Library".
<http://www.vitechcorp.com/Project/c0622ad2-23be-4cf1-ab47-eec8714e5361/entityDefinition/78387dce-388b-4f78-
8897-2f50d139b1e2> dc:description ""An entity is a \"thing\" that can be uniquely identified. From an object-
oriented perspective, entities are objects. Individual entities are related to each other by relationships.
Individual entities have characteristics called attributes or parameters.
Entities are collected into entity classes. Some examples of entity classes are: Requirement, Function, Issue,
and Component.""";
                                dc:identifier "78387dce-388b-4f78-8897-2f50d139b1e2";
                                rdfs:label "Element";
                                rdfs:subClassOf owl:Class.
genesys:GenesysParameterValue rdfs:subClassOf owl:Class.
genesys:GenesysValue rdfs:subClassOf owl:Class.
```

TURTLE FILE

The generated file contains the entities included in the viewpoint in alphabetical order by class name. Then entities, attributes, properties, and parameters will also be listed in alphabetical order under each class. Relationship information will also be included.

The generated file is encoded with the RDF standard.

8. CREATING MULTIPLE VIEWS OF A DIAGRAM

GENESYS has the capability to create multiple views of a diagram. This feature enables GENESYS users to create several versions of the same diagram with different properties, styles and templates containing different information. It also saves time for GENESYS users since they can create new views from previously formatted views or from the default view.

The sample below shows the default view for the Geospatial Library EFFBD diagram, created with a template containing name, number and allocation information and with yellow fill color selected for the nodes.

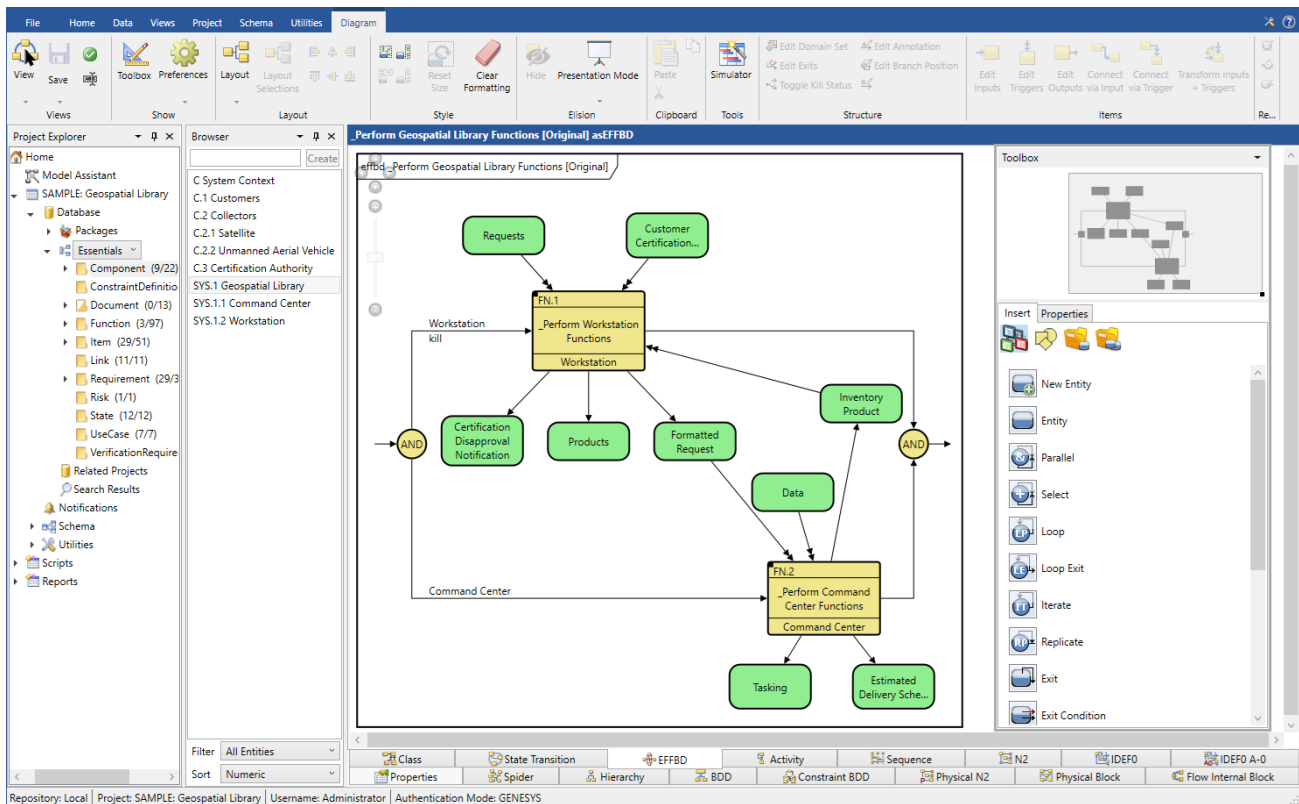

Creating a New View Based on the Default View

1. To create a new view of the diagram based on the default layout of the diagram, select the

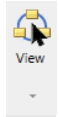

View icon on the **Diagram** tab and select **New** on the drop-down menu.

2. Enter a name for the new view in the window that displays.

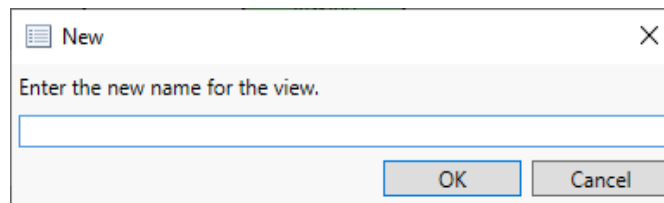

A new view with the same layout as the original view is created with the new name that you assigned.

Systems Engineering Guided Tour

Creating a New View Based on Another Formatted View

If you add new formatting to a view using the toolbox properties and then save it with a new name by clicking **Save** on the *Diagram* ribbon, you can base other views on this formatted view.

1. Open the view that you want to base a new view on, add any additional formatting changes, and then click **Save As** on the *Diagram* ribbon to save the new view with a new name.

The view below, named Light Blue_Name Operations, created from the same diagram, was based on a previously formatted view that used a template containing name and operations information and light blue fill color selected for the nodes.

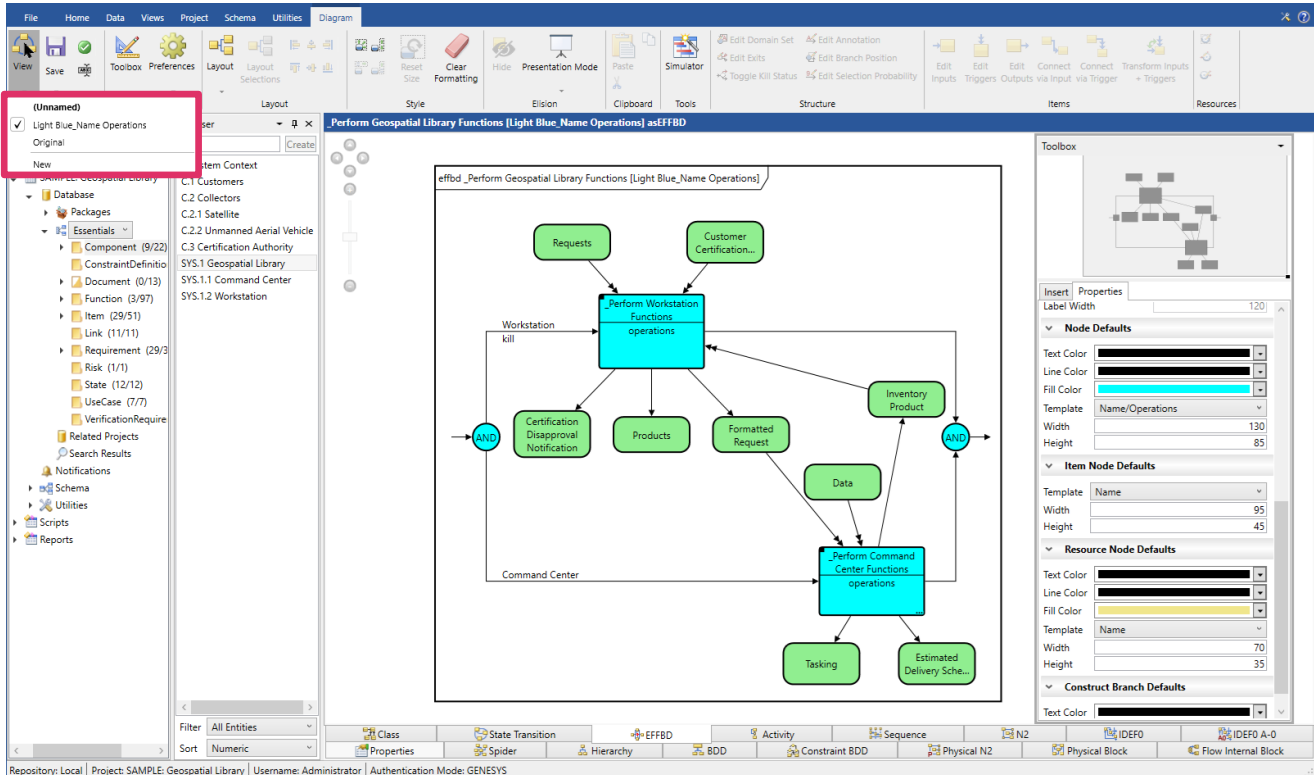

Viewing All Available Views for a Diagram



To view all available views for a diagram, select the **View** icon on the *Diagram* tab and select the one that you want from the drop-down menu.

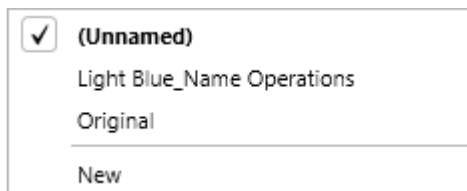

Systems Engineering Guided Tour

Displaying View Metadata

To display view metadata, select the **Views** tab at the bottom of an entity's property sheet. The **Views** tab lists all views that exist for an entity. The metadata includes diagram type, view name, whether it is the default view, created by, created date and time, modified by, and modified date and time. These fields dynamically update as the view metadata changes.

Diagram Type	View Name	Default	Created By	Created	Modified By	Modified
BDD	(Unnamed)	True	Administrator	8/21/2017 11:30:47 AM	Administrator	8/21/2017 11:30:47 AM
ConstraintBDD	(Unnamed)	True	Administrator	1/8/2016 4:32:10 PM	Administrator	6/8/2022 8:09:35 AM
FlowInternalBlock	(Unnamed)	True	Administrator	12/15/2015 3:57:47 PM	Administrator	10/22/2020 11:26:51 AM
PhysicalBlock	(Unnamed)	False	Administrator	10/22/2020 11:19:50 AM	Administrator	6/9/2022 9:28:04 AM
PhysicalBlock	Architoon	True	Administrator	12/15/2015 11:08:40 AM	Administrator	10/22/2020 11:19:46 AM
PhysicalIN2	(Unnamed)	True	Administrator	8/21/2017 11:32:54 AM	Administrator	12/3/2018 7:34:24 AM

Attributes Properties Parameters Diagnostic **Views**

Relationships: (all relationships), assigned to, augmented by, built from, built in, categorized by, causes, connected to, constrained by

Targets & Attributes: augmented by ExternalFile Geospatial Library Graphic, built from Component SYS.1.1 Command Center, built from Component SYS.1.2 Workstation, built in Component C System Context, connected to Link L.1 Request-Product Link, connected to Link L.2 Command - Imagery Products Link, connected to Link L.3 Status Link, connected to Link L.4 Certification Link

Sort: Numeric by class

Repository: Local | SAMPLE: Geospatial Library | Username: Administrator | Authentication Mode: GENESYS

Preventing Accidentally Overwriting a View

A warning message is displayed to prevent GENESYS users from accidentally overwriting a view. This can happen when two users are working on the same view concurrently, or if a GENESYS user has the same view open in multiple windows.

Systems Engineering Guided Tour

When the user attempts to save the diagram, and the view was saved by another window or user since the diagram was opened, a warning message displays with options to save the diagram as a new view with a different name, overwrite the view, or cancel the changes to the view.

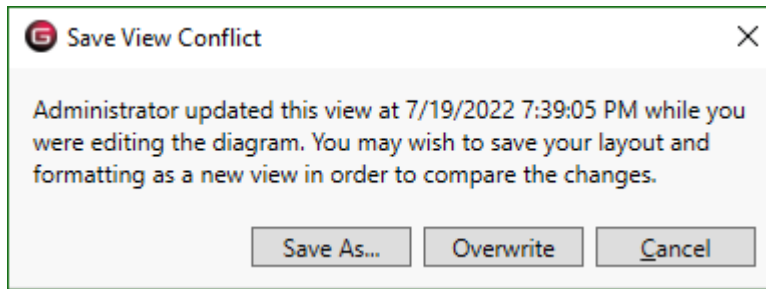

If the user attempts to close the diagram window without saving it, and the view was saved by another window or user since the diagram was opened, the following warning message displays with an additional option to discard the new view.

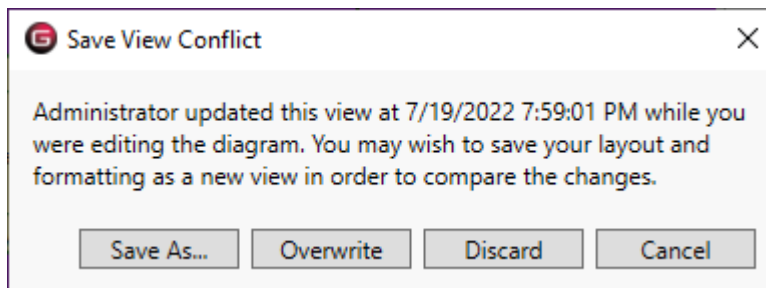

Saving a Diagram as an Image

To save a diagram as an image, select **Save** on the *Diagram* ribbon and **Save As Image** on the drop-down menu that appears, then enter a name for the image, and browse to the location where you want to save it.

Displaying Multiple Diagram Views on Reports

GENESYS has the capability to display multiple diagram views on reports.

1. In *Project Explorer* under *Reports*, select the report category that you want to view.

All the reports in that category are displayed in the *Browser* pane in the center of the window.

In the example below, we selected *SDD* reports and the *SDD Report by Component*.

Systems Engineering Guided Tour

The screenshot displays a software application interface with a ribbon menu at the top containing 'File', 'Home', 'Data', 'Views', 'Project', 'Schema', and 'Utilities'. The 'Schema' ribbon is active, showing options like 'Check Schema Consistency', 'Cancel Schema Edits', 'End Schema Editing', 'New Class', 'New Facility', 'New Relations', 'New Attribute', 'Add Target Class', 'New Parameter', and 'Add Relation'. Below the ribbon are three panes: 'Project Explorer', 'Browser', and 'SDD Report (by Component) asPropertySheet'. The 'Project Explorer' pane shows a tree view with 'SDD (3/106)' highlighted. The 'Browser' pane shows 'SDD Report (by Component)' selected. The 'SDD Report (by Component) asPropertySheet' pane shows the report's name and description. The description states: 'The System Description Document (SDD) Report is a customized report developed by Vitech Corporation to provide a concise and comprehensive report on the system design. The SDD report includes sections on: Component Definition, Requirements (originating, performance, and constraints), Interfaces & Links, Functional Model, Issues & Concerns, Risks, Use Cases, Item Dictionary, Resources, Subordinate Components, Requirements Traceability Matrix, Acronyms and a Glossary. When the report is run, the user is prompted to select a component from the COMPONENT class which is then the basis for all of the output.' At the bottom, the status bar shows 'Repository: Local | Project: SAMPLE: Geospatial Library | Username: Administrator | Authentication Mode: GENESYS'.

Project Explorer

- Risk (1/1)
- State (12/)
- UseCase (
- Verification
- Related Projec
- Search Results
- Notifications
- Schema
- Utilities
- Scripts
- Reports
 - Attribute History
 - Common Subrepc
 - Diagnostics (2/2)
 - DoDAF 2.0 (52/12
 - IRS (1/8)
 - Project Compare
 - Report Designer D
 - Reporting Toolkit
 - Risk Report (1/5)
 - Schema Definition
 - Schema Migration
 - SDD (3/106)**
 - SSDD (1/10)
 - SSS (1/24)
 - TABLEMaker (4/4)

Browser

- SDD Report (by Component)
- SDD Report (by Package)
- SDD Report (by Project)

SDD Report (by Component) asPropertySheet

Name	SDD Report (by Component)
Description	The System Description Document (SDD) Report is a customized report developed by Vitech Corporation to provide a concise and comprehensive report on the system design. The SDD report includes sections on: Component Definition, Requirements (originating, performance, and constraints), Interfaces & Links, Functional Model, Issues & Concerns, Risks, Use Cases, Item Dictionary, Resources, Subordinate Components, Requirements Traceability Matrix, Acronyms and a Glossary. When the report is run, the user is prompted to select a component from the COMPONENT class which is then the basis for all of the output.
Created	Administrator 11/16/2012 11:32:02 AM
Modified	Administrator 5/14/2021 3:27:45 PM

Repository: Local | Project: SAMPLE: Geospatial Library | Username: Administrator | Authentication Mode: GENESYS

Systems Engineering Guided Tour

2. Select the report section or subreport where you want the multiple views to display by clicking the arrow next to the report category (in this case *SDD* reports) in *Project Explorer*.
3. Then select the *Sections* or *Subreports* folder that contains the section or subreport you want to edit.

The list of report sections or subreports will be displayed in the *Browser* pane.

4. Right-click on the report section or subreport that you want to edit and then select *Edit* on the drop-down menu that appears.

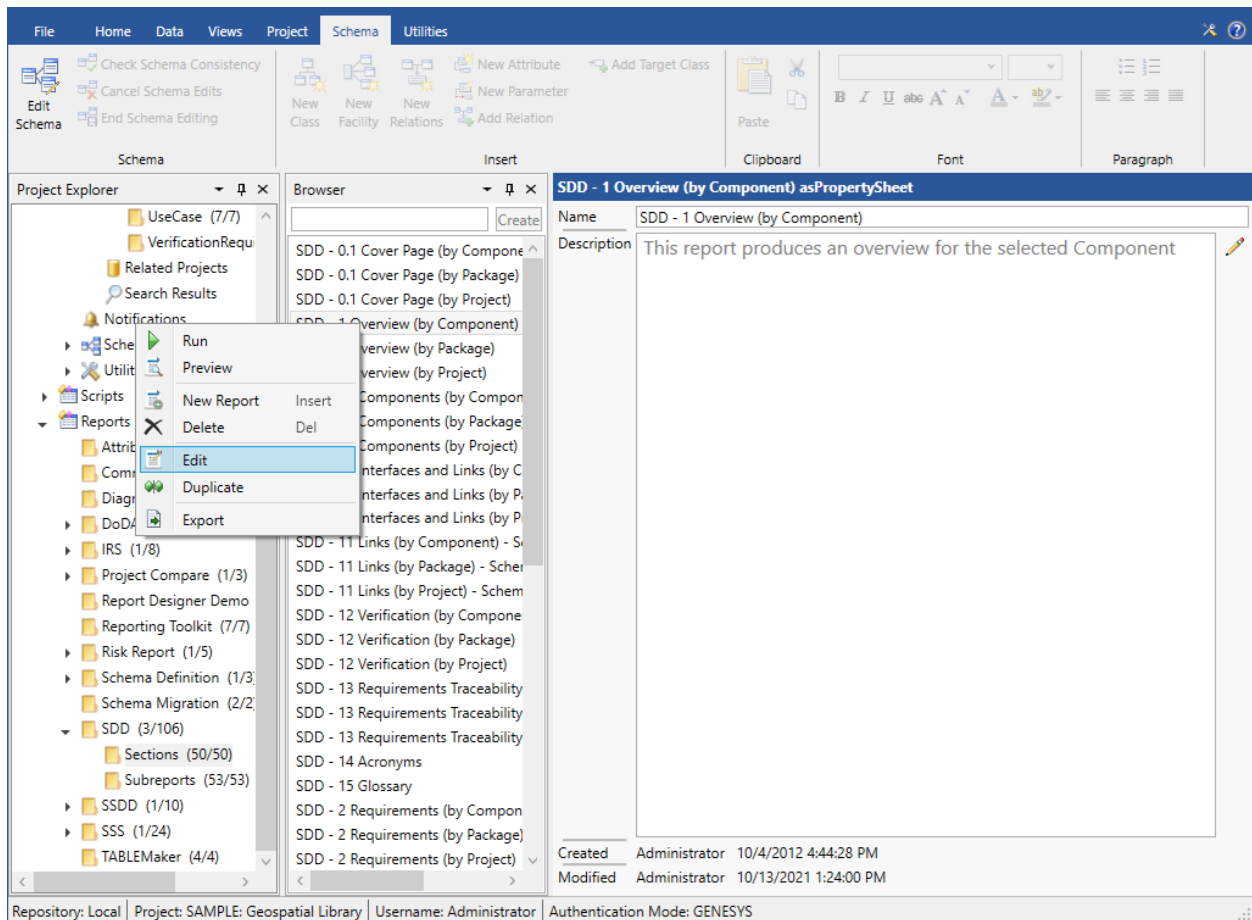

Systems Engineering Guided Tour

The Report Designer where you edit the report opens.

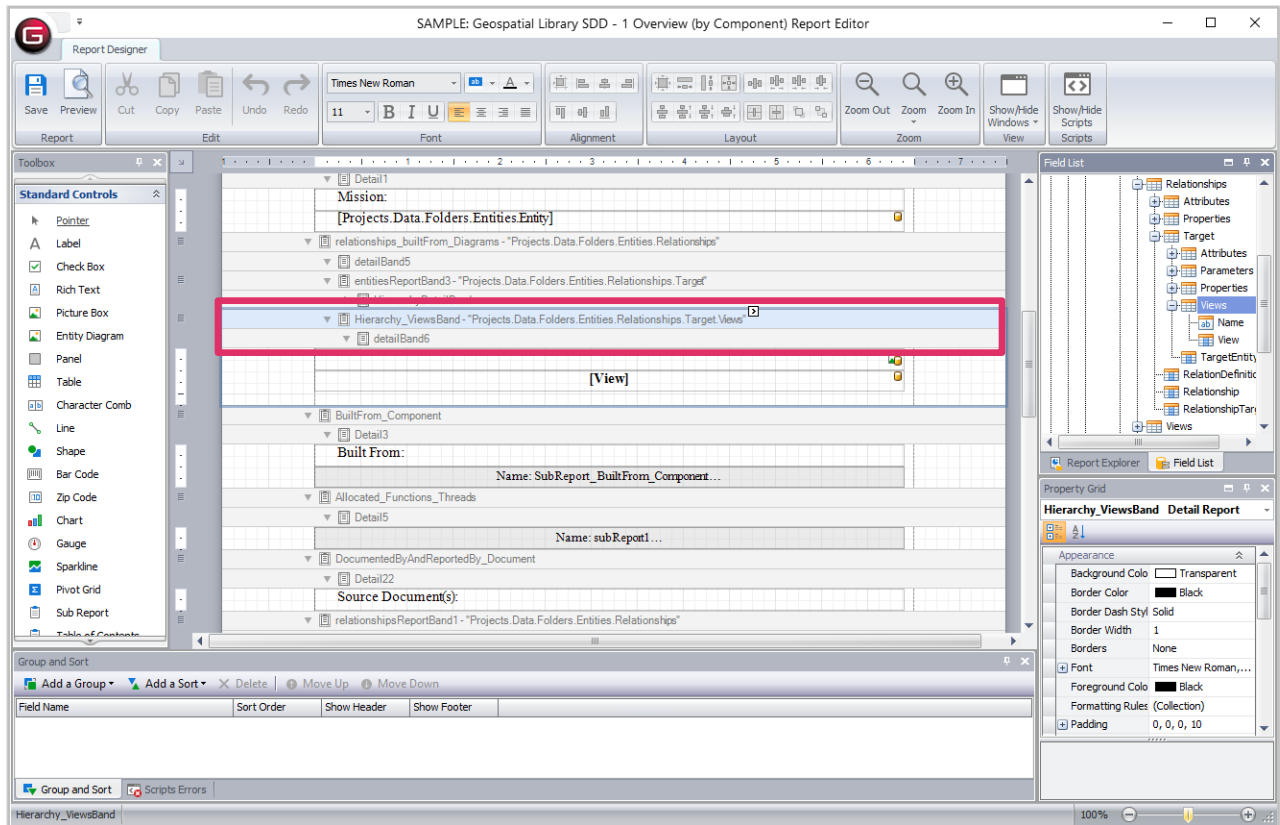

5. Find the report section or subreport you want to edit in the center of the window and then click the button next to it that looks like a greater than symbol .

Systems Engineering Guided Tour

The following window appears.

6. Select *All Views* for the **View Output** field. By default, the default view displays.

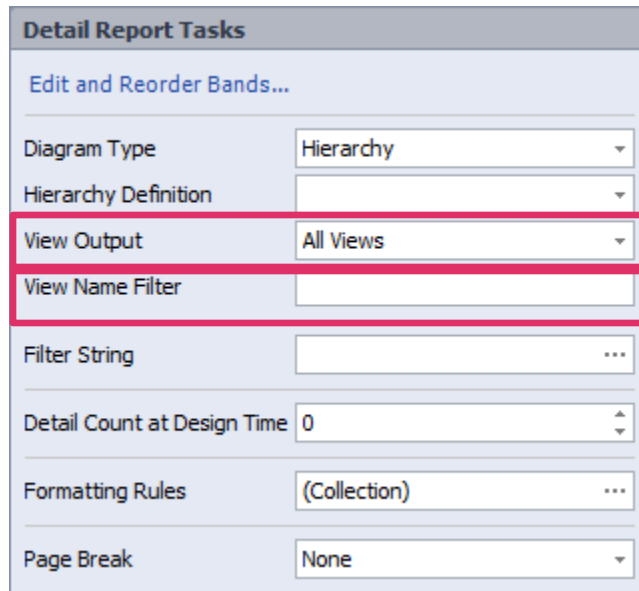

Detail Report Tasks	
Edit and Reorder Bands...	
Diagram Type	Hierarchy
Hierarchy Definition	
View Output	All Views
View Name Filter	
Filter String	
Detail Count at Design Time	0
Formatting Rules	(Collection)
Page Break	None

7. To filter which views display, enter a filter in the **View Name Filter** field. For example, if you enter "Main", all views with "Main" in the name will display.

You can also use a wildcard filter by entering a part of the name followed by an asterisk (i.e., "ma*" and all views starting with the letters "ma" will display on the report.

Systems Engineering Guided Tour

- To run the report to see the multiple views, right-click on the report name and then select *Run* on the drop-down menu that displays.

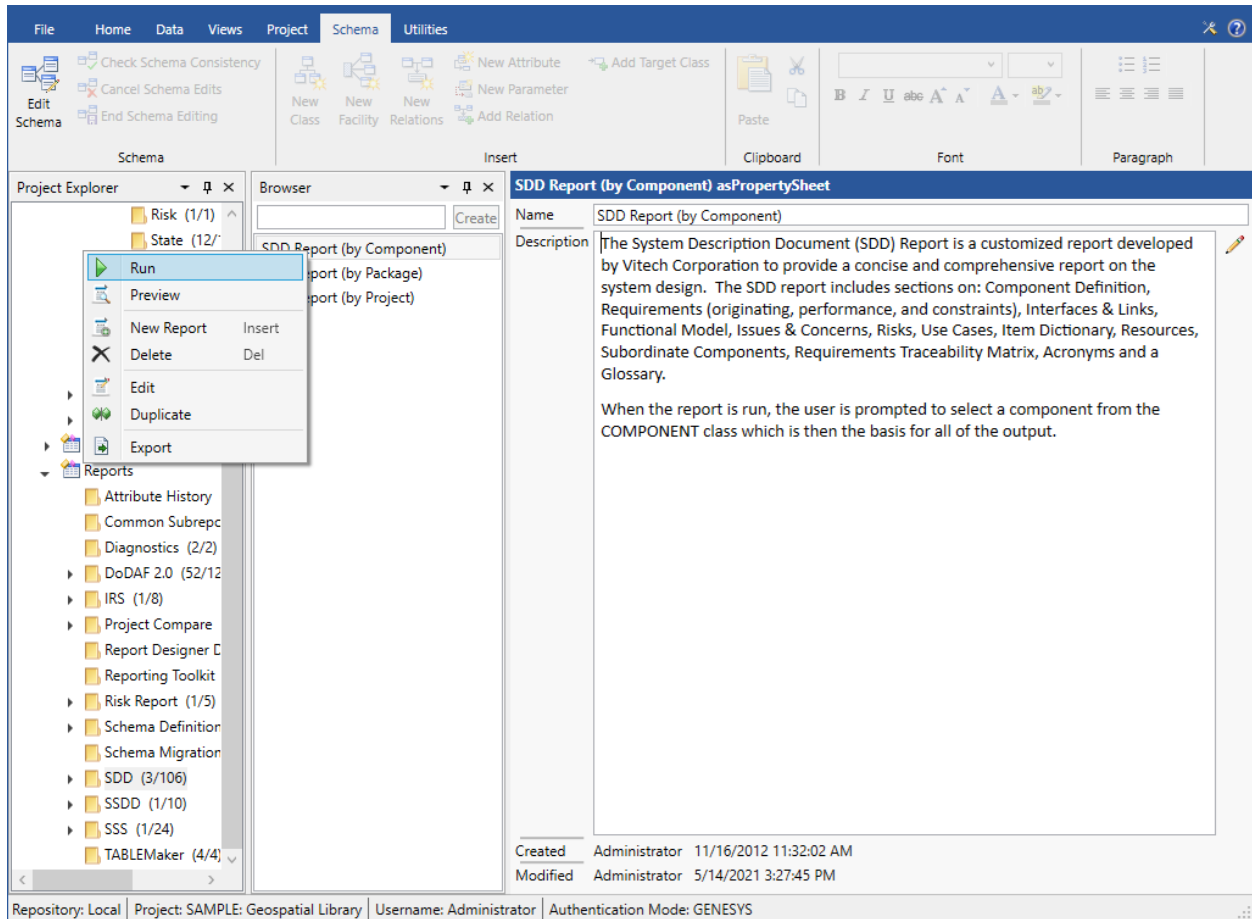

- Select a location to save the report.
- Then, select the parameters for the report in the dialog box that appears.

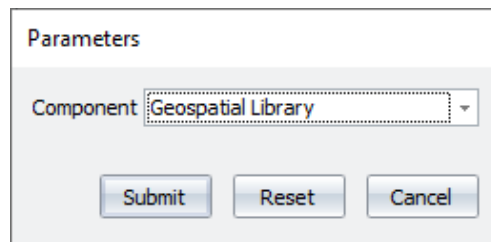

Systems Engineering Guided Tour

Multiple views of the *System Context*, *Physical Block* diagram display on the *SDD Report by Component* report shown below.

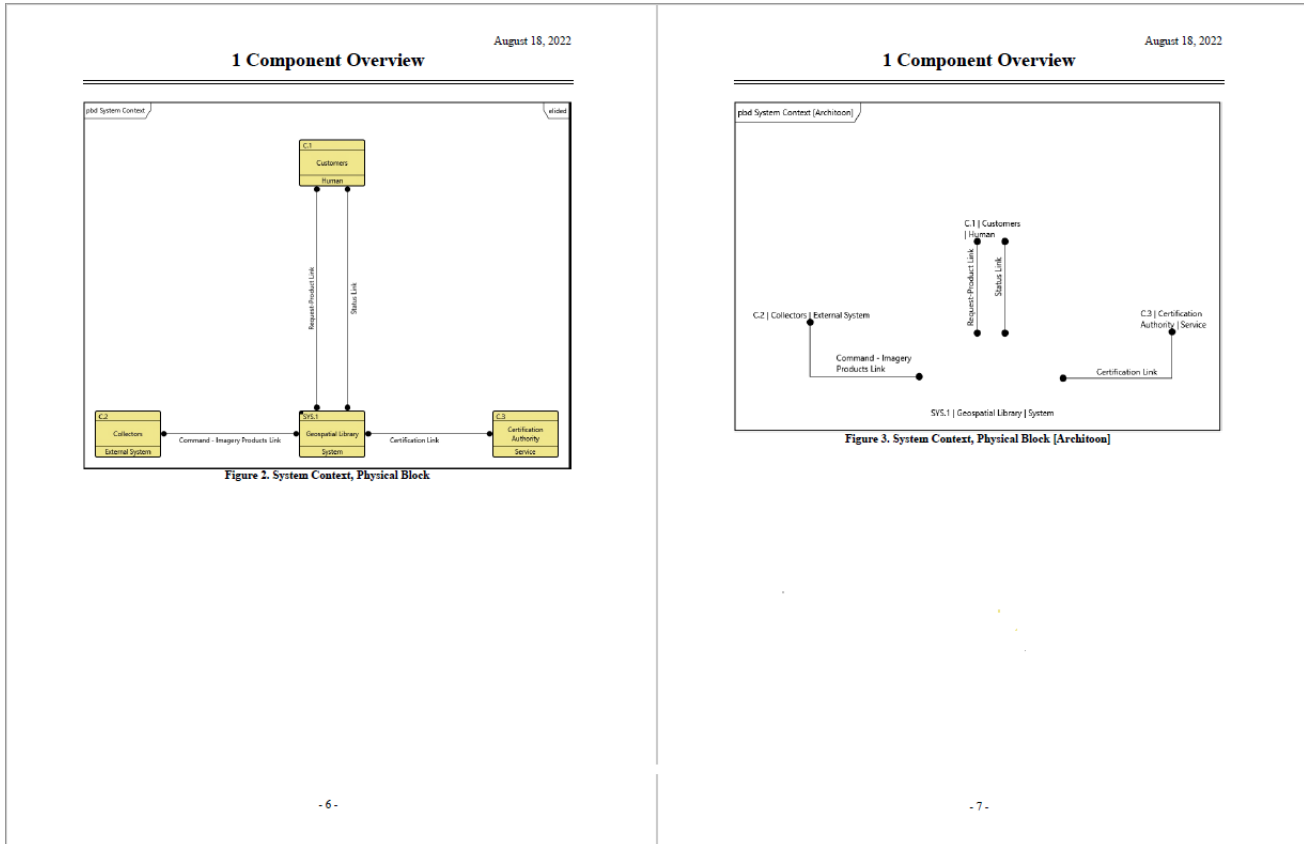

9. STRUCTURED VIEWS OF DIAGRAMS

Structured views of diagrams enable GENESYS users to create lists of diagram views that direct modelers and other GENESYS users to the important diagrams for various tasks and purposes. Modelers can use these view lists to create model overview roadmaps, to build lists of diagrams for design review presentations, or to export to share with external stakeholders, and for many other purposes. The view lists can also contain *Table Views*.

GENESYS contains four types of structured view lists:

- **Project Pinned** - enables a modeling team to flag (pin) views important to the team.
- **User Favorites** - enables team members to flag diagrams that are most important to their individual work and current views that they are working on.
- **Filtered** – enables users to filter the views based on specific criteria.
- **Custom** – enables users to create customized lists of views for specialized purposes.

Project Pinned, **User Favorites**, **Filtered**, and **Custom** view lists are viewable by all users with access to the project. Each user can view only their own **User Favorites** list.

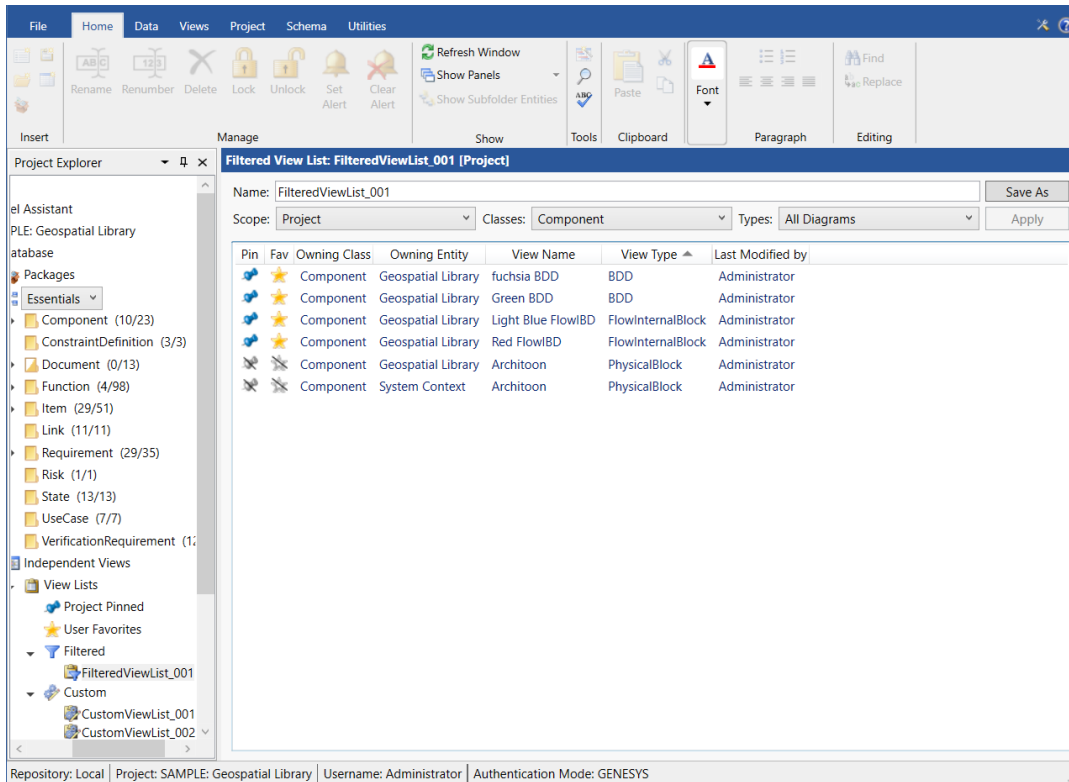

Systems Engineering Guided Tour



To save time creating view lists, users can modify an existing view list and save it with a new name. They can also create variants of lists for various applications of the modeling team.

Users can also flag diagram views in view lists to find them more easily.

By selecting a **Pin**  or **Star**  icon on the **Diagram** ribbon when working on a diagram, or on any of the view lists, users can add the diagram to the **Project Pinned** or **User Favorites** view list, respectively.

The **Star**  icon will change color to **yellow**, indicating that the diagram is a **User's Favorite** diagram, and the **Pin** icon will change color to **blue**  to indicate that the diagram is on the **Project Pinned** view list, making the diagram types easily recognizable.

They can also add diagrams to any **Custom** view list from the view lists or by selecting the **View List**

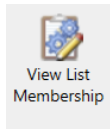

Membership button on the **Diagram** ribbon.

Users can remove diagrams from the view lists by selecting the icons on the **Diagram** ribbon or on the view lists. These actions can be undone/redone by selecting the **Undo** and **Redo** icons.

If another user adds a diagram to the **Project Pinned**, **User Favorites**, or **Custom** view lists, that diagram will dynamically appear in the relevant view list.

The view lists feature includes extensive search functionality. Users can search for saved diagram views by diagram name, diagram type, and class making all the diagrams in the system easily accessible. The **Views** search also includes **Table Views**.

Systems Engineering Guided Tour

GENESYS saves the search results in the **Search Results** section of *Project Explorer*, making them available for future reference and for easy access. Users can conveniently drag-drop the search results from the *View Search Results* window directly to the **Project Pinned/User Favorites/Custom** view lists.

For additional information about structured views of diagrams, refer to the online help.

10. TABLE VIEWS

The *Table Views* feature in GENESYS enables users to view table views of GENESYS data within GENESYS instead of having to export the data to Excel. *Table Views* are an excellent way to work with the entities in a model and present them with their associated attributes and relationships. They make the modeling data easily accessible and easy for users from various disciplines to comprehend.

Table Views includes a powerful editing feature that accesses all the built-in editors in GENESYS including the Scripts Editor, Number Specs Editor, Entity Reference Editor, and Reference Spec Editor where users can edit the data directly in GENESYS. Everything editable in an entity property sheet in GENESYS is also editable in a *Table View* and is saved in the GENESYS database. It's also possible to add new entities directly into GENESYS from a *Table View*.

Table Views also dynamically update when data in GENESYS changes.

Table Views can be based on various pre-formatted templates called *Table Definitions* and can include packages, folders, or classes. Users can also edit the *Table Definition* for a *Table View* from within GENESYS just like they would edit it in Excel and create customized *Table Definitions*.

The *Table View* shown below is based on the *Requirements Table Definition*.

Number	Requirement	Type	Description	Parent Requirement
R.1	Continuous Support a...	Composite	The Geospatial Library shall provide contin...	
R.1.1	Continuous Support	Constraint	The Geospatial Library shall provide...	R.1 Continuous Supp...
R.1.2	Availability	Constraint	The system shall be unavailable no mo...	R.1 Continuous Supp...
R.2	Specific Requirements	Composite	1. The system shall accept information req...	
R.2.1	Accept Requests fro...	Composite	The system shall accept information reques...	R.2 Specific Requirements
R.2.1.1	Accept Requests	Composite	The system shall accept information requests.	R.2.1 Accept Requests f...
R.2.1.1.1	Accept Media of Requests	Composite	The system shall accept requests via any o...	R.2.1.1 Accept Requests
R.2.1.1.1.1	Media of Reques...	Functional	The system shall accept requests v...	R.2.1.1.1 Accept Media...
R.2.1.1.1.2	Media of Requests: Verbal	Functional	The system shall accept verbal requests.	R.2.1.1.1 Accept Media...
R.2.1.1.1.3	Media of Requests: Verb...	Functional	The system shall accept requests v...	R.2.1.1.1 Accept Media...
R.2.1.1.1.4	Media of Requests: Tel...	Functional	The system shall accept requests v...	R.2.1.1.1 Accept Media...
R.2.1.1.1.5	Media of Requests: W...	Functional	The system shall accept requests via a W...	R.2.1.1.1 Accept Media...
R.2.1.2	Certify Customers	Functional	The system shall certify customers.	
R.2.1.2.1	Validate Certifi...	Functional	The system shall validate the custome...	R.2.1.2 Certify Customers
R.2.2	Retain Inventory a...	Composite	The system shall retain an inventory of...	R.2 Specific Requirements
R.2.2.1	Retain Inventory	Functional	The system shall retain an inventory...	R.2.2 Retain Inventory a...
R.2.2.2	Provide Products	Functional	The system shall provide previously collect...	R.2.2 Retain Inventory a...
R.2.3	Control Multiple Colle...	Composite	The system shall control multiple ima...	R.2 Specific Requirements
R.2.3.1	Control Multip...	Functional	The system shall control multiple ima...	R.2.3 Control Multiple...
R.2.3.2	Control Multiple Collect...	Functional	The system shall control multiple types...	R.2.3 Control Multiple...
R.2.4	Maximum Staff	Constraint	The system shall be staffed at a maximum...	R.2 Specific Requirements
R.2.5	Provide Feedback	Performance	The system shall provide feedback on t...	R.2 Specific Requirements
R.2.6	Prioritize Requests	Functional	The system shall provide a means...	R.2 Specific Requirements
R.2.7	Monitor and Asse...	Composite	The system shall monitor and assess its o...	R.2 Specific Requirements

Data can be copied and pasted from a *Table View* into MS Excel where users can manipulate the data with advanced Excel features.

For additional information about *Table Views*, refer to the online help.

11. MATRIX VIEWS

What it is

Matrix Views are a data visualization grid that shows the relationships between entities in a system. The Matrix View feature is a powerful tool for gaining insights into complex systems by providing a customized visual representation of how individual entities are related within a class and scope. In GENESYS, Matrix Views are part of the suite of Independent View types.

Why it is useful

Use a Matrix View to identify gaps in your project's traceability or to show traceability coverage. For example, Matrix Views can demonstrate how system requirements are linked to lower-level design requirements, providing a way to visually verify that all requirements are adequately flowed down and connected across different system levels.

Another application example is to use Matrix Views to visually verify that all requirements and functions are allocated to components in the physical architecture. Users have the flexibility to create as many Matrix Views as needed, each dynamically adjustable to include different entities, ensuring that each Matrix View is tailored to meet specific project needs. Matrix Views can help to flag areas where entities may not have been properly related or allocated to other portions of the systems architecture model, providing a visual indication of completeness.

How to use it

Users specify the Class and Scope for the rows and columns of the Matrix View and choose which Dependency Relationships to display in the grid. Matrix Views can display one or more Dependency Relationship types between a Source and a Target. These relationships are visualized with color-coded arrows or text strings. The Matrix Views feature has the functionality to edit Relationships in real time or remove Relationships as needed, allowing users to address any gaps or inconsistencies in requirement coverage immediately. For easy reference, a Matrix View can be exported for use on other platforms.

Matrix View example

Source (row): Component Target (col): Component	Component	System Context [Geospatial Library Class Project]	Geospatial Library [Geospatial Library Class Project]	Command Center [Geospatial Library Class Project]	Command Center	Workstation [Geospatial Library Class Project]	Interface	Test Database
<ul style="list-style-type: none"> ↕ Relation ↔ Cross-Project Relation ↕ built from ↗ owns ↖ kind of ↗ generalization of ↖ owned by ↘ built in 								
Component		↔	↔					↘
System Context	↕			↔				↕
Customers			↔		↕		↕ ↖	↘
Collectors	↕	↔						↖
Satellite	↘		↔ ↖ ↖	↔				↕
Vehicle	↕ ↕		↖		↘		↕ ↖ ↘	
Certification Authority		↔						
Geospatial Library					↕			

12. GENERATING DOCUMENTATION

In this section, you will generate outputs from GENESYS.

- Output a System Description Document
- Generate TeamView
- Review Standard Reports available in GENESYS

Generating a System Description Document (SDD)

A System Description Document (SDD) presents your project's primary systems engineering entities in a structured manner for reviewing your physical and behavior model and related information. For each entity appearing in the SDD, key attributes and relations are listed. User-selected diagram types are also included, as appropriate.

Typically, an SDD is generated for the system or one of its lower-level **Components**. Only the entities directly or indirectly related to the selected **Component** and its physical hierarchy are included. Alternatively, all systems engineering entities can be included.

1. In the *Project Explorer* pane, expand the Reports branch.
2. Select the **SDD** folder.
3. In the *Browser* pane, select *SDD Report (by Component)*.
4. Right-click on the report and select **Run**.
5. When prompted for the file name and location, review these, set as desired, and click **Save**.
6. In the Parameters dialog, select *Geospatial Library*, then click **Submit**.

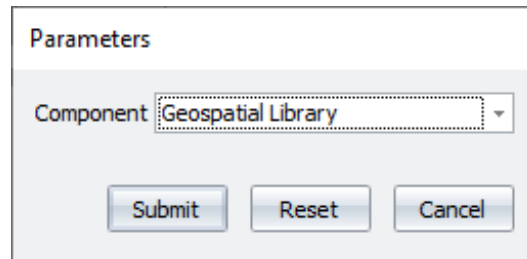

You will see this dialog while the report runs. The report will be finished when this dialog closes.

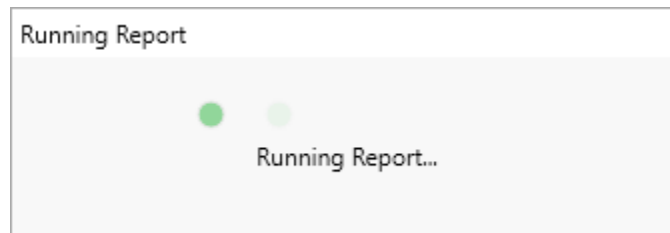

7. Navigate to the location where you saved the file and double-click to open.

Systems Engineering Guided Tour

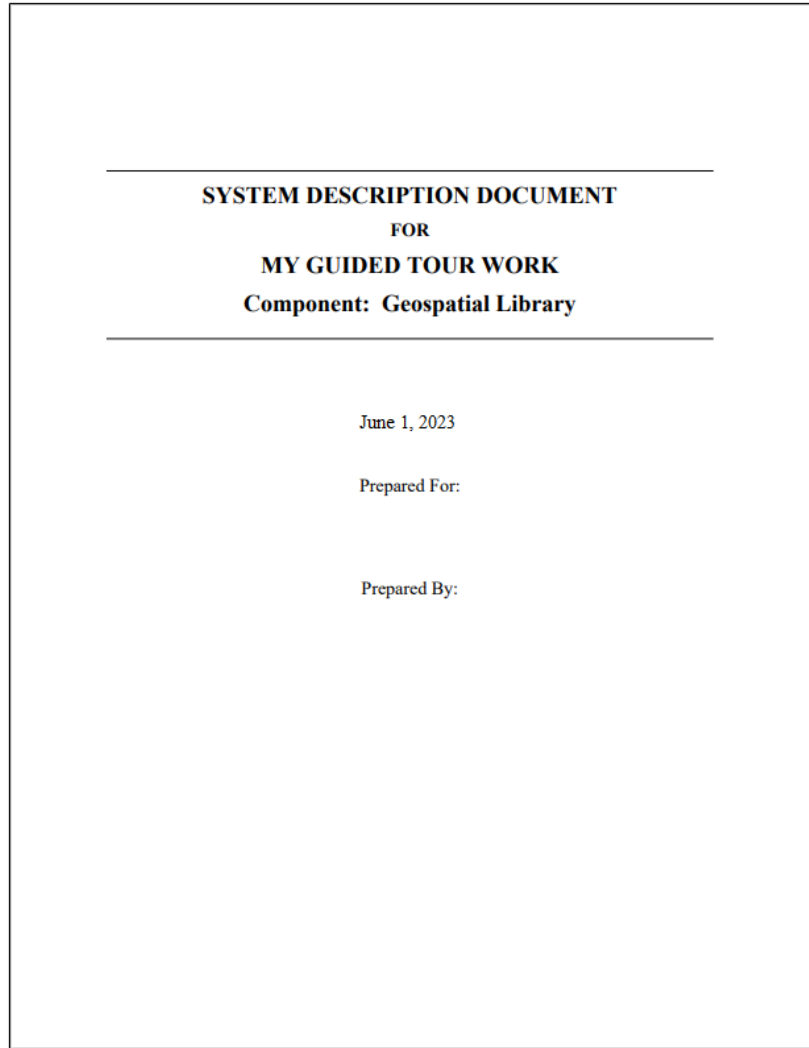

Generating TeamView

Another report available in GENESYS outputs the contents of the system design repository in HTML format and generates a Home Page accessible by anyone with a Web browser.

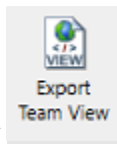

1. Click the **Export TeamView** icon on the *Utilities* ribbon.

Systems Engineering Guided Tour

Team View for "My Guided Tour Work"

Main Options

Team View Script: TeamViewEntity

Save files to directory: C:\TeamView Output

Project POC name:

Project POC email:

Show blank attributes? Yes No

Sort entity and target lists by number? Yes No

Diagram Views: Default View All Views

View Name Filter:

Default to Graphical View

Available Diagrams

Selected Diagrams

Activity

BDD

Class

ConstraintBDD

EEFRD

Custom Styles

Homepage text:

Left-align Center

Homepage logo:

Font family: Arial

Font size: 10

Link hover color: green

Primary BG color: #3f5f7b

Primary BG font color: white

Secondary BG color: #eaeaea

Secondary BG font color: black

Generate Cancel

2. Select a location where the report Home Page can be saved by clicking on the ***Ellipsis*** button next to the ***Save files to directory*** field at the top of the window. (Make sure that you create a folder for the output since it may contain hundreds of files.)
3. Select other options on the window as desired or leave the default settings.
 - Show blank attributes - can be used as a diagnostic to see what attributes are not filled in.
 - Sort entity and target lists by number - *No* will sort and show lists alphabetically.
 - Diagram Views - Only show the default view for each diagram or all stored views.
 - View Name Filter - Used in conjunction with All Diagram Views to filter based on view name (wildcard * and ? can be used for matching names.)
 - Default to Graphical View - Default view is a property sheet. Selecting this option will default to a diagram view based on the default view in the script.
4. Click ***Generate***.

You will be prompted when TeamView completes processing.

Systems Engineering Guided Tour

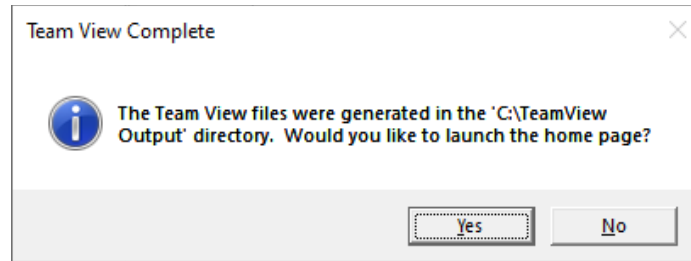

5. Click **Yes** to launch TeamView in your default web browser.

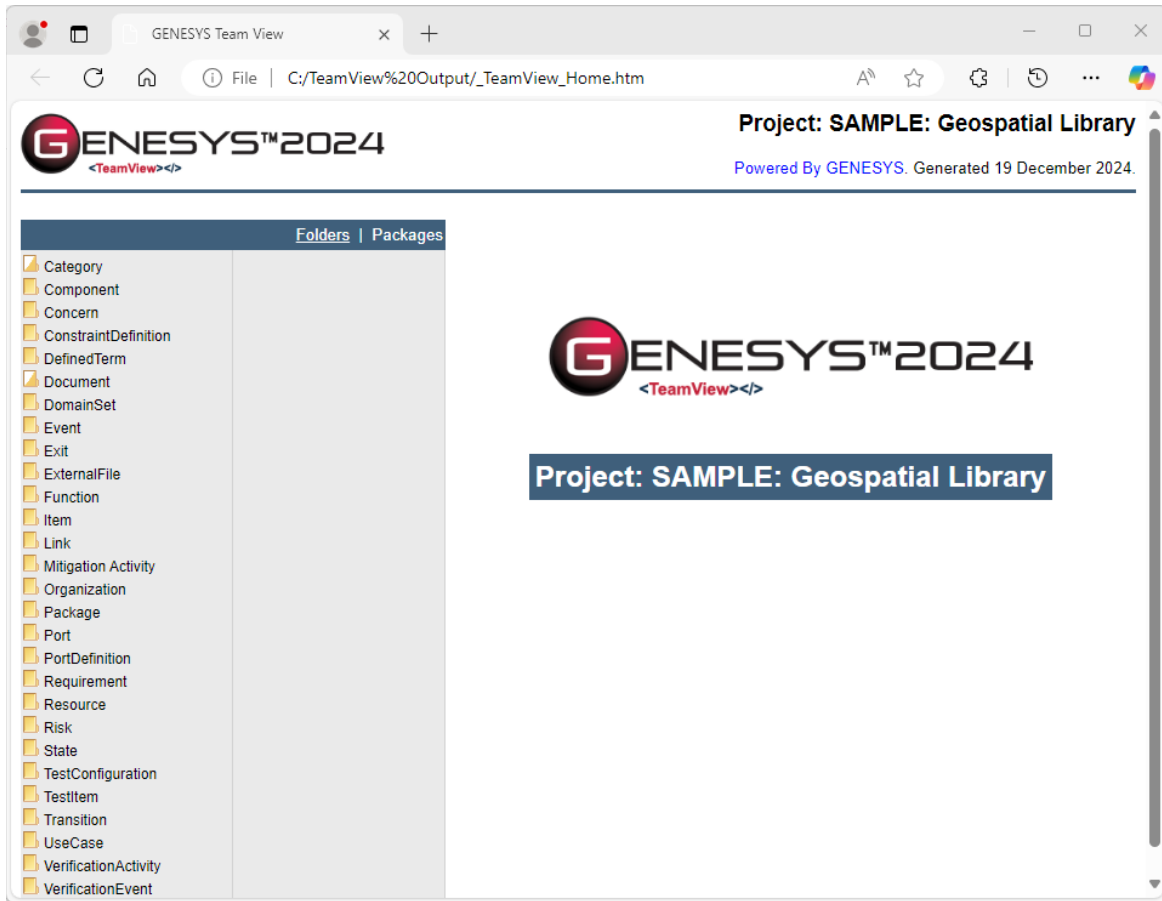

Clicking on a class/folder link in the left-hand list displays the corresponding entities on the right. From this list, you can select any entity to display its property sheet.

6. For example, click on the **Component** link. On the right, a list of all entities in the **Component** class is displayed.
7. Click on *C System Context* to show the property sheet.

Systems Engineering Guided Tour

The screenshot shows the GENESYS 2024 Team View interface. The browser address bar indicates the URL is C:/TeamView%20Output/_TeamView_Home.htm. The page title is 'Project: SAMPLE: Geospatial Library' and it is powered by GENESYS, generated on 19 December 2024. On the left, there is a 'Folders | Packages' tree view with categories like Category, Component, Concern, etc. The main content area displays 'Component / System Context' details. At the top right of this section, there are two dropdown menus: 'Type' set to 'Property Sheet' and 'View' set to 'Default', both highlighted with a red box. Below these are sections for 'Attributes | Parameters' and 'Relationships'. The 'Attributes | Parameters' section includes fields for Name (System Context), Number (C), Description, Type (Context), and Operations (Make Requests). The 'Relationships' section lists 'built from' (Component: C.1 Customers, C.2 Collectors, C.3 Certification Authority) and 'exhibits' (State: Exhibit System Context States) and 'performs' (Function: C Perform System Context Functions).

If *All Views* is selected for *Diagram Views*, a **View** drop-down list appears on the top right side of the page, listing all the views for the entity. When users select a type, the associated view is automatically selected.

At the **Type** drop-down list above the **View** drop-down list, if *Property Sheet* is selected for the **Type**, *Default* will be selected automatically as the view, as shown above.

8. In the *Relationships* portion of the entity information, each relationship Target is a link to the text view for that entity. If the selected function has a diagram associated with it, users can access the diagram by selecting the link from the **Type** drop-down list located at the top of the text view.

In the example below, we selected the **Requirement** class/folder and the *Performance Self-Assessment* entity within this class. Since this entity contains multiple views, when we select *Hierarchy – Traceability* for the **Type**, the *Hierarchy – Traceability* view is selected for the view at the **View** drop-down list. This diagram will display in the window in place of the entity attributes and relationships. Each **Entity** and **Link** icon is a hyperlink to that entity.

Systems Engineering Guided Tour

The screenshot shows the GENESYS 2024 Team View interface. The browser address bar indicates the file path: C:/TeamView%20Output/_TeamView_Home.htm. The project name is 'SAMPLE: Geospatial Library', and it was generated on 19 December 2024. The left-hand navigation pane lists various folders and packages, including 'Requirement'. The central workspace displays a requirement hierarchy diagram titled 'hier Performance Self Assessment'. The diagram shows a top-level requirement 'R.2.7.2.1 Performance S... Requirement' which is refined by two sub-requirements: 'R.2.7.2.1 Measure Cust... Requirement' and 'R.2.7.2.2 Measure Orde... Requirement'. The right-hand control panel has two dropdown menus, both set to 'Hierarchy : Traceability'.

9. Close the browser.

Congratulations!

You have completed your first system design using GENESYS. Now, it's time to save your final model.

With this guided tour as a desktop reference, experiment by designing your own system. Remember that GENESYS is far more powerful and flexible than we have shown in this simple example. Experiment with the other features and capabilities to get a better idea of what you can do. In fact, you will discover that with GENESYS, you'll have more time for engineering your system.

Systems engineering should be productive and fun. We believe that using GENESYS is both.

13. STANDARD REPORTS AVAILABLE IN GENESYS

Attribute History

- Attribute History Report

Common Subreports

- Augmentation Output
- External File Figure
- Relationship Targets
- TOC_List of Figures
- TOC_List of Tables
- TOC_Table of Contents

Diagnostics

- Diagnostics Results Report v1.0
- Diagnostics Table Report v1.0

DoDAF

- AV-1 Overview and Summary Information
- AV-2 Integrated Dictionary
- CV-1 Vision
- CV-2 Capability Taxonomy
- CV-3 Capability Phasing
- CV-4 Capability Dependencies
- CV-5 Capability to Organizational Development Mapping
- CV-6 Capability to Operational Activities Mapping
- CV-7 Capability to Services Mapping
- DIV-1 Conceptual Data Model
- DIV-2 Logical Data Model
- DIV-3 Physical Data Model
- OV-1 High-Level Operational Concept Graphic
- OV-2 Operational Resource Flow Description
- OV-3 Operational Resource Flow Matrix
- OV-4 Organizational Relationships Chart
- OV-5a Operational Activity Decomposition Tree
- OV-5b Operational Activity Model
- OV-6a Operational Rules Model
- OV-6b State Transition Description
- OV-6c Event-Trace Description
- PV-1 Project Portfolio Relationships
- PV-2 Project Timelines
- PV-3 Project to Capability Mapping
- StdV-1 Standards Profile
- StdV-2 Standards Forecast
- SvcV-1 Services Context Description
- SvcV-2 Services Resource Flow Description

- SvcV-3a Systems-Services Matrix
- SvcV-3b Services-Services Matrix
- SvcV-4 Services Functionality Description
- SvcV-5 Operational Activity to Services Traceability Matrix
- SvcV-6 Services Resource Flow Matrix
- SvcV-7 Services Measures Matrix
- SvcV-8 Services Evolution Description
- SvcV-9 Services Technology & Skills Forecast
- SvcV-10a Services Rules Model
- SvcV-10b Services State Transition Description
- SvcV-10c Services Event-Trace Description
- SV-1 Systems Interface Description
- SV-2 Systems Resource Flow Description
- SV-3 Systems-Systems Matrix
- SV-4 Systems Functionality Description
- SV-5a Operational Activity to Systems Function Traceability Matrix
- SV-5b Operational Activity to Systems Traceability Matrix
- SV-6 Systems Resource Flow Matrix
- SV-7 Systems Measures Matrix
- SV-8 Systems Evolution Description
- SV-9 Systems Technology & Skills Forecast
- SV-10a Systems Rules Model
- SV-10b Systems State Transition Description
- SV-10c Systems Event-Trace Description

IRS

- IRS Report

Project Compare

- Project Compare Report

Reporting Toolkit

- Closed Concerns Report
- Component Hierarchy Report
- Cross Reference Matrix Report
- Functional Hierarchy Report
- Open Concerns Report
- Requirements Hierarchy Report
- Work Breakdown Structure (WBS) Report

Systems Engineering Guided Tour

Risk Report

- Risk Report

Schema Definition

- Schema Definition Report

Schema Migration

- 2020 Schema Migration Check
- 2021 R2 Schema Migration Check

SDD

- SDD Report (by Component)
- SDD Report (by Package)
- SDD Report (by Project)

SSDD

- SSDD Report

SSS

- SSS Report

TABLEMaker

- General Concerns Report
- Open Concerns Report
- TABLEMaker
- TABLEMaker (5 Attrib)



2270 Kraft Drive, Suite 1600
Blacksburg, Virginia 24060
+1 540 951 3322 | Fax: +1 540 951 8222
www.vitechcorp.com

Customer Support:
+1 540 951 3999 | support@vitechcorp.com